

• CUSTOMER SERVICE • INNOVATION • MANUFACTURING • QUALITY • TECHNICAL EXPERTISE • EXCELLENCE • DESIGN •



The Right Connection®

## Quick Release Products

Customer Service: **+44 (0)1772 323529**

Email: **sales@dixoneurope.co.uk**



[www.dixoneurope.co.uk](http://www.dixoneurope.co.uk)



# Quick Release Couplings

H Series: ISO 7241 Series B Interchange.....	7	<b>A</b>
H-Series ISO-B Food Grade Couplings.....	12	<b>B</b>
HS-Series ISO-B Steam Interchange.....	13	<b>C</b>
K-Series ISO7241 Series ‘A’ Interchange .....	15	<b>D</b>
AG-Series Agricultural Interchange.....	18	<b>E</b>
VEP-Series Threaded Flushface Interchange .....	21	<b>F</b>
TR-Series TEMA European Interchange .....	23	<b>G</b>
W Series Wing Style Interchange.....	25	<b>H</b>
HT-Series ISO16028 Flushface Interchange .....	29	<b>I</b>
HTE-Series ISO 16018 Connect Under Pressure .....	33	<b>J</b>
ST-Series Snap-Tite ‘71’ Interchange .....	35	<b>K</b>
WS-Series High Pressure Wingstyle .....	39	<b>L</b>
Blowout Prevention Safety Couplings .....	42	<b>M</b>
PD-Series ISO15171-1 Diagnostic Interchange.....	49	<b>N</b>
V Series: Snap-Tite H/IH Interchange.....	50	<b>O</b>
T-Series High Pressure Screw-Together .....	57	<b>P</b>
CVV-Series European Screw-Together Interchange .....	59	<b>Q</b>
E-Series Straight-Through Interchange .....	61	<b>R</b>
EA-Series Water-Blast Interchange.....	64	<b>S</b>
DF-Series Industrial Interchange.....	65	<b>T</b>
BR-Series Rectus ‘21’ Interchange.....	71	<b>U</b>
J-Series Truflate Automotive Interchange.....	73	<b>V</b>
CJ-Series European High-Flow Interchange .....	76	<b>W</b>
N Series Bowes/MacDonald Interchange.....	78	<b>X</b>
P-Series Thor Interchange .....	84	<b>Y</b>
Dry Disconnect Couplings .....	87	<b>Z</b>



## Be Safe When Selecting Quick Couplings!

**!** All quick disconnect couplings should be viewed as potential hazards that can cause property damage, personal injury or even death if used or installed improperly! Improper use includes selecting a product unsuitable for your application, installing or using the product incorrectly and ignoring signs of imminent failure or mis-use. Failure may result in explosive propulsion of components, rapid expulsion of hazardous media, and failure or unintentional movement of a fluid powered component.

### Proper Selection of Quick Disconnect Couplings

The very properties that make a compressed media useful in almost every area of modern life can also make them dangerous when mishandled. Dixon quick disconnect couplings have been carefully engineered to meet specific industry requirements while maintaining abundant safety margins. If quick disconnect couplings are not used in the correct applications or are incorrectly applied, accidents and downtime can result. It is up to the end user to inform the distributor of the application and pressures involved when ordering quick disconnect couplings and it is up to the distributor to supply the right coupling for the application.

The use of S.T.A.M.P.E.D. will help in the proper selection of quick disconnect coupling products. When in doubt, Dixon Quick Coupling will provide information, including test results (if available), coupling recommendations and other data to help resolve quick disconnect coupling related issues.

### S.T.A.M.P.E.D. Questions and Selection Process

- Size** Couplings should be selected to handle the flow and pressure requirements of the system. Excessive pressure drop will result in restricted flow, slower actuation, higher fluid velocity, heat generation and eventually a breakdown of fluids, seals and components.
1. What size coupler is required?
  2. What is the maximum allowable pressure drop for the application?
  3. Are there any size restrictions due to a 'tight-spot' installation?
- Temperature** Media and ambient temperatures must be limited to the specific operating parameters of the selected sealing materials. Excessive cold will reduce sealing capability while excessive heat can cause the premature breakdown of body and valve seals.
1. What is the media/fluid temperature?
  2. What is the ambient temperature?
  3. Are there any 'flash' heat or fire sources near the connection?
- Application** Quick coupling interchangeability is a key issue that needs to be closely reviewed. There are several instances where non-interchangeable couplers and nipples may connect. This is very dangerous and these couplings should never be pressurised. Be sure to match like series couplers and nipples!
1. Is an industry interchange coupler required?
  2. What are the functional requirements of the coupling?
  3. Have there been any problems with other couplings in this application?
- Media** Quick disconnect couplings are available with a variety of body materials and seal options. Exposure to harsh and corrosive operating environments may reduce service life. Several quick couplings spill fluid upon disconnection which may be a safety concern!
1. Which seal and body materials are compatible with the system fluid?
  2. Is air inclusion, system contamination or fluid loss a concern?
  3. Is this fluid dangerous to the operator?
- Pressure** During the selection process, the published working pressure of the coupling must be equal to or greater than the maximum system pressure. Surge pressures in a fluid power system, higher than the rated pressure, will shorten the service life of the coupling.
1. Is the pressure 'Static' or 'Dynamic'?
  2. What is the maximum operating pressure required for the application?
  3. Are there any pressure spikes in the system?
- Ends** Many end configurations are available and each one has specific operating parameters. For example, the working pressure of couplings utilizing Hose Barb or Collar Hose Barb end connections may be dramatically reduced. If in doubt, test under controlled conditions for suitability to the application.
1. What end configuration and size is required? (Male Threaded, Female Threaded, or Hose Barb)
  2. Does the chosen end configuration support the application parameters and system pressure?
  3. What is the ideal valving configuration? (Single Shut-off, Double Shut-off, or Unvalved)
- Details** Forgotten or missed application details can cause a failure if not properly addressed! Be meticulous in the assessment of your application to ensure that all parameters are considered in the selection of the proper quick disconnect coupling.
1. Are there any side-load, vibration or swivelling problems associated with the application?
  2. Does the coupling require a safety sleeve-lock mechanism?
  3. Are there any environmental concerns that need to be addressed?

## Fluid Compatibility Guide

The following chart is intended only as a guide in selecting various elastomers and metals for use with fluids to be conveyed through Dixon Quick Disconnect Couplings. This list does not guarantee suitability for a particular application. Final selection is dependent upon operating pressure, fluid and ambient temperature, concentration of media, duration of exposure, environmental conditions, and frequency of connect and disconnect.

MATERIAL	PREFIX CODE	TRADE NAME	RANGE °C	RANGE °F
Buna-N	Standard	Nitrile	-40°C to +121°C	-40°F to +250°F
Buna-N (MIL-H-5606 Fluids)	M-	Nitrile	-54°C to +135°C	-65°F to +275°F
Buna-N (Hydrocarbon Fuels)	JF-	Nitrile	-54°C to +71°C	-65°F to +160°F
Fluorocarbon Rubber	F-	FKM	-29°C to +204°C	-20°F to +400°F
Ethyl Propylene Diene Monomer	P-	EPDM	-54°C to +149°C	-65°F to +300°F
Neoprene	E-	Neoprene	-43°C to +149°C	-45°F to +300°F
Silicone	S-	Silicone	-73°C to +177°C	-100°F to +350°F
Fluorosilicone (FVMQ)	FS-	Silastic®	-60°C to +180°C	-76°F to +376°F
Urethane	U-	Urethane	-40°C to +82°C	-40°F to +180°F
Polyurethane	UP-	Polyurethane	-54°C to +100°C	-65°F to 212°F
PTFE Encapsulated Silicone	TS-	TES	-73°C to +204°C	-100°F to +400°F
PTFE Encapsulated Fluorocarbon	TF-	TEF	-73°C to +204°C	-100°F to +400°F
Perfluoroelastomer (Compound 1)	K4-	Kalrez® 4079	-20°C to +316°C	-4°F to +600°F
Perfluoroelastomer (Compound 2)	K6-	Kalrez® 6375	-20°C to +275°C	-4°F to +525°F
Perfluoroelastomer (Compound 3)	K7-	Kalrez® 7075	-20°C to +327°C	-4°F to +620°F
Fluoroelastomer	H-	Aflas®	-5°C to +204°C	+23°F to +400°F

MEDIA NAME	SUGGESTED SEAL	MEDIA NAME	SUGGESTED SEAL	MEDIA NAME	SUGGESTED SEAL
Acetic Anhydride	P-	Freon, General	E-	Mineral Spirits	Standard
Acetone	P-	Ferric Hydroxide	Standard	Nickel Acetate	P-
Acetylene	Standard	Formaldehyde (50%)	P-	Nickel Suphate	P-
Air (To 200°F)	Standard	Fuel Oils, General	Standard	Nitrogen, Gas	Standard
Air (Above 200°F)	F-	Gasoline	Standard	Nitrous Oxide	Standard
Alcohol, Ethyl	P-	Glycerine (Glycerol)	Standard	Octane	F-
Alcohol, Methyl	Standard	Glycols	P-	Oleum Spirits	Standard
Alkalies, General	Standard	Helium	Standard	OS45 and OS45-1	F-
Ammonia, Aqueous	P-	Heptane	Standard	Oxygen, Non-Breathing	F-
Ammonia, Gas	P-	Hexane	Standard	Paint Thinner	F-
Ammonia, Anhydrous	P-	Hydraulic Oil, Aircraft	Standard	Paraffin	Standard
Ammonia, Hydroxide	P-	Hydraulic Oil, Petroleum	Standard	Peanut Oil	Standard
Aroclor	F-	Hydraulic Oil, Phosphate	P-	Pentane	Standard
Benzene (Benzol)	F-	Hydrogen Gas	Standard	Perchloroethylene	F-
Bleach Solutions	P-	Hydrolube	Standard	Phosphoric Acid (100%)	P-
Brake Fluid, Non-Petro	P-	Isobutyl Alcohol	P-	Photographic Solutions	P-
Bromine Gas	F-	Isopropyl Alcohol	F-	Potassium Acetate	P-
Butane	Standard	Jet Fuel (to 160°F)	JF-	Propane	Standard
Butyl Alcohol	Standard	Jet Fuel (above 160°F)	F-	Propylene	F-
Carbon Dioxide, Dry	Standard	Kerosene	Standard	Propylene Glycol	Standard
Carbon Dioxide, Wet	Standard	Lindol	P-	Silicone Oil	Nitrile
Carbon Monoxide	Standard	LP Gas	Standard	Steam, General Service	H-
Carbon Tetrachloride	F-	Magnesium Hydroxide	F-	Stoddard Solvent	Standard
Cellulube	P-	Methane	Standard	Sulphuric Acid (100%)	F-
Creosote	F-	Methanol	Standard	Toluene	F-
Crude Oil	F-	Methyl Bromide	F-	Transmission Fluid (A)	Standard
Cutting Oil	Standard	Methyl Ethyl Ketone (MEK)	P-	Trichloroethylene	F-
Diesel Fuel	Standard	MIL-F-81912 (JP-9)	P-	Turpentine	Standard
Diester Lubricants	F-	MIL-H-5606	M1-	Vegetable Oil	Standard
Ethane	Standard	MIL-H-5806	Standard	Water	Standard
Ethanol	Standard	MIL-H-6083	Standard	Water, Distilled	Standard
Ethyl Chloride	Standard	MIL-H-7083	Standard	Water, Dionized	Standard
Ethylene Glycol	P-	Mineral Oils	Standard	Water, Sea	P-

# Quick Release Couplings

## Part Number Structure

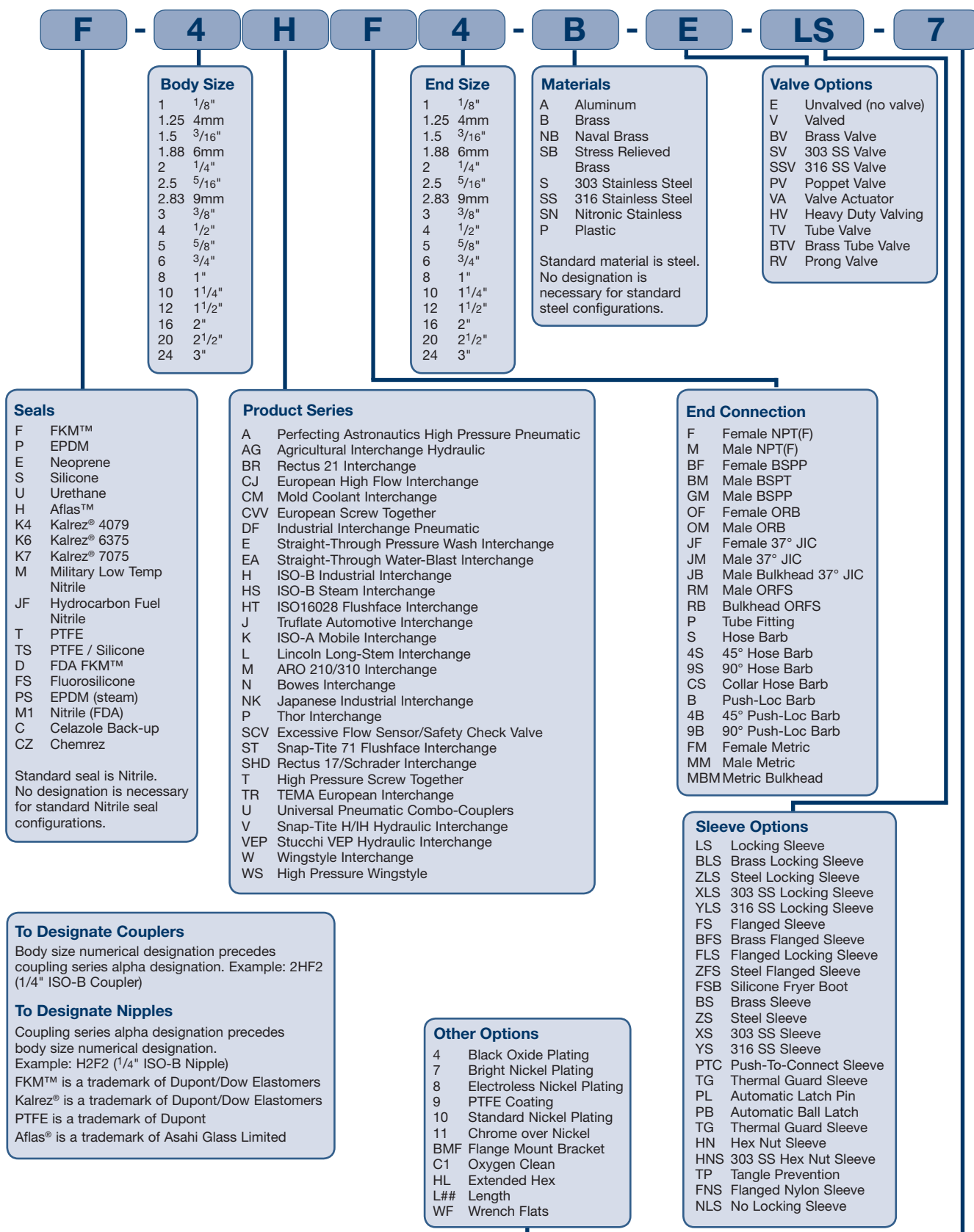

Many variations of the part numbers contained within this guide can be ordered utilizing the format shown above. However, some variations may require minimum order quantities, longer lead times, and/or price adjustments based upon the uniqueness of construction. Please contact your Dixon Quick Coupling representative for details regarding your particular coupling configuration

## H Series ISO 7241 Series B Interchange

### Interchange Data:

- Interchangeable to ISO7241 Series 'B'
- Parker 60-Series, Snap-Tite 72-Series, Hansen HK-Series, Faster Series 'HNV' Aeroquip/Eaton FD45, Stucchi Series IRB/IRBO/IRBX



### Materials:

- Machined components are manufactured using solid Steel, Brass, 303 Stainless Steel or 316 Stainless Steel bar stock
- Stainless Steel balls, retaining rings, and springs maximise corrosion resistance and extend service life
- Steel componentry is plated using ROHS Compliant Trivalent Chrome
- Steel coupler sleeves are hardened to resist deformation and maximise service life
- Steel nipples are hardened to provide heavy duty performance and resist brinelling

### Seal Components:

- Nitrile (Buna-N) seals are standard providing a temperature range of -40°C to +121°C (-40°F to +250°F)
- 1/8" to 1" Steel and stainless couplers have a PTFE anti-extrusion ring
- 1/8" to 2 1/2" Brass couplers have a redundant O-Ring sealing system (dual O-Rings/no PTFE back-up ring)
- 1 1/4" to 2 1/2" Steel and stainless couplers have a redundant o-ring sealing system (dual O-Rings/no PTFE back-up ring)
- Valve seals are crimped in place to maintain integrity during excessive flow conditions and pressurised connection

### Rated Pressure Chart:

H-SERIES ISO-B INTERCHANGE (CONNECTED)																
BODY SIZE	STEEL COUPLER/PLUG				BRASS COUPLER/PLUG				303 STAINLESS COUPLER/PLUG				316 STAINLESS COUPLER/PLUG			
	Max. Working		Burst		Max. Working		Burst		Max. Working		Burst		Max. Working		Burst	
	PSI	Bar	PSI	Bar	PSI	Bar	PSI	Bar	PSI	Bar	PSI	Bar	PSI	Bar	PSI	Bar
1/8"	4,000	275	14,500	1,000	3,000	200	16,500	1,100	3,500	240	29,500	2,000	3,500	240	29,500	2,000
1/4"	5,000	345	22,500	1,550	3,000	200	15,000	1,000	3,500	240	31,500	2,150	3,500	240	33,000	2,200
3/8"	4,000	275	16,500	1,150	2,500	175	12,000	800	3,500	240	26,500	1,800	3,500	240	28,000	1,900
1/2"	4,000	275	16,000	1,100	2,500	175	11,500	750	3,500	240	27,500	1,900	3,500	240	22,000	1,500
3/4"	4,000	275	16,500	1,150	2,000	138	12,000	800	3,000	200	16,000	1,100	3,000	200	21,500	1,450
1"	4,000	275	16,000	1,100	1,500	100	8,500	600	2,000	138	15,000	1,000	2,000	138	15,000	1,000
1 1/4"	2,500	170	10,000	700	1,000	70	6,500	450	2,000	138	10,000	700	1,000	70	8,500	580
1 1/2"	2,500	170	12,500	850	1,000	70	6,500	450	1,500	100	8,500	580	1,000	70	7,000	480
2 1/2"	1,500	100	6,000	400	700	50	5,500	380	1,000	70	6,500	450	900	62	6,000	400

# Quick Release Couplings

A

## Technical Specifications:

BODY SIZE	INTERCHANGE STANDARDS				FUNCTIONAL PARAMETERS				
	U.S. MILITARY	U.S. GOVERNMENT	INTERNATIONAL STANDARDS	ANSI/NFPA STANDARDS	LOCKING BALL QUANTITY	AIR INCLUSION	FLUID LOSS	VACUUM INCH HG	FLOW $\Delta P = 22 \text{ PSI}$ L/MIN
1/8"	-	-	ISO7241 'B'	B93.113M-B	8	0.6cc	0.3cc	27.4	11
1/4"	-	-	ISO7241 'B'	B93.113M-B	8	1.1cc	0.9cc	27.4	4.5
3/8"	-	-	ISO7241 'B'	B93.113M-B	9	2.6cc	1.8cc	27.4	45
1/2"	-	-	ISO7241 'B'	B93.113M-B	9	3.8cc	2.9cc	27.4	68
3/4"	-	-	ISO7241 'B'	B93.113M-B	12	10.8cc	9.7cc	27.4	109
1"	-	-	ISO7241 'B'	B93.113M-B	12	15.9cc	15.3cc	27.4	188
1 1/4"	-	-	ISO7241 'B'	B93.113M-B	12	30.0cc	45.0cc	N/R	388
1 1/2"	-	-	ISO7241 'B'	B93.113M-B	12	60.0cc	75.0cc	N/R	451
2 1/2"	-	-	ISO7241 'B'	B93.113M-B	15	N/A	N/A	N/R	733



### H-SERIES ISO-B INTERCHANGE (NIPPLE MALE THREAD)

PART NO.	BODY SIZE	THREAD SIZE	BODY MATERIAL
H2M3	1/4"	3/8" - 18 NPTF	Steel
H4M6-S	1/2"	3/4" - 14NPTF	303 Stainless Steel



### H-SERIES ISO-B INTERCHANGE DUST CAPS AND PLUGS

BODY SIZE	COUPLER DUST PLUG	NIPPLE DUST CAP	MATERIAL
1/8"	1HDP	H1DC	Nitrile
1/4"	2HDP-H2DC combo plug/cap		Nitrile
3/8"	3HDP-H3DC combo plug/cap		Nitrile
1/2"	4HDP-H4DC combo plug/cap		Nitrile
3/4"	6HDP-H6DC combo plug/cap		Nitrile
1"	8HDP-H8DC* combo plug/cap		Nitrile

\* 8HDP-H8DC fits both 1" and 1 1/4" body sizes



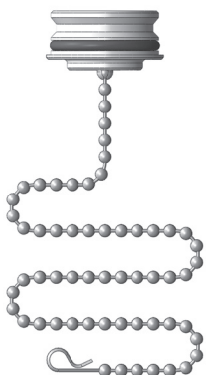

H-SERIES ISO-B INTERCHANGE COUPLER RIGID DUST PLUG			
PART NO	BODY SIZE	LANYARD	BODY
2HDP-A	1/4"	SS bead chain	Aluminium
3HDP-A	3/8"	SS bead chain	Aluminium
4HDP-A	1/2"	SS bead chain	Aluminium
6HDP-A	3/4"	SS bead chain	Aluminium
8HDP-A	1"	SS bead chain	Aluminium
12HDP-A	1 1/2"	SS bead chain	Aluminium
20HDP-A	2 1/2"	SS bead chain	Aluminium



H-SERIES ISO-B INTERCHANGE NIPPLE RIGID DUST CAP			
PART NO	BODY SIZE	LANYARD	BODY
H2DC-A	1/4"	SS bead chain	Aluminium
H3DC-A	3/8"	SS bead chain	Aluminium
H4DC-A	1/2"	SS bead chain	Aluminium
H6DC-A	3/4"	SS bead chain	Aluminium
H8DC-A	1"	SS bead chain	Aluminium
H12DC-A	1 1/2"	SS bead chain	Aluminium
H20DC-A	2 1/2"	SS bead chain	Aluminium



(Female Thread)

H-SERIES ISO-B STEEL MILL 'SLIDE-GATE' INTERCHANGE (COUPLER)			
PART NO.	BODY SIZE	THREAD SIZE	BODY MATERIAL
4HF4-HV	1/2"	1/2" - 14 NPTF	Steel



(Female Thread)

H-SERIES ISO-B STEEL MILL 'SLIDE-GATE' INTERCHANGE (NIPPLE)			
PART NO.	BODY SIZE	THREAD SIZE	BODY MATERIAL
H4F4-HV	1/2"	1/2" - 14 NPTF	Steel

# Quick Release Couplings

A



(Female Thread)

## H-SERIES ISO-B INTERCHANGE (COUPLER)

PART NO.	BODY SIZE	THREAD SIZE	BODY MATERIAL
1HF1	1/8"	1/8"-27 NPTF	Steel
1HF1-B	1/8"	1/8"-27 NPTF	Brass
1HF1-S	1/8"	1/8"-27 NPTF	303 Stainless Steel
1HF1-SS	1/8"	1/8"-27 NPTF	316 Stainless Steel
1HOF2	1/8"	7/16"-20 ORB	Steel
2HF2	1/4"	1/4"-18 NPTF	Steel
2HF2-B	1/4"	1/4"-18 NPTF	Brass
2HF2-S	1/4"	1/4"-18 NPTF	303 Stainless Steel
2HF2-SS	1/4"	1/4"-18 NPTF	316 Stainless Steel
2HOF3	1/4"	9/16"-18 ORB	Steel
2HOF3-S	1/4"	9/16"-18 ORB	303 Stainless Steel
2HOF3-SS	1/4"	9/16"-18 ORB	316 Stainless Steel
2HBF2	1/4"	1/4"-19 BSPP	Steel
2HBF2-B	1/4"	1/4"-19 BSPP	Brass
2HBF2-S	1/4"	1/4"-19 BSPP	303 Stainless Steel
2HBF2-SS	1/4"	1/4"-19 BSPP	316 Stainless Steel
3HF3	3/8"	3/8"-18 NPTF	Steel
3HF3-B	3/8"	3/8"-18 NPTF	Brass
3HF3-S	3/8"	3/8"-18 NPTF	303 Stainless Steel
3HF3-SS	3/8"	3/8"-18 NPTF	316 Stainless Steel
3HOF4	3/8"	3/4"-16 ORB	Steel
3HOF4-S	3/8"	3/4"-16 ORB	303 Stainless Steel
3HOF4-SS	3/8"	3/4"-16 ORB	316 Stainless Steel
3HBF3	3/8"	3/8"-19 BSPP	Steel
3HBF3-B	3/8"	3/8"-19 BSPP	Brass
3HBF3-S	3/8"	3/8"-19 BSPP	303 Stainless Steel
3HBF3-SS	3/8"	3/8"-19 BSPP	316 Stainless Steel
4HF4	1/2"	1/2"-14 NPTF	Steel
4HF4-B	1/2"	1/2"-14 NPTF	Brass
4HF4-S	1/2"	1/2"-14 NPTF	303 Stainless Steel
4HF4-SS	1/2"	1/2"-14 NPTF	316 Stainless Steel
4HOF5	1/2"	7/8"-14 ORB	Steel
4HOF5-S	1/2"	7/8"-14 ORB	303 Stainless Steel
4HOF5-SS	1/2"	7/8"-14 ORB	316 Stainless Steel
4HBF4	1/2"	1/2"-14 BSPP	Steel
4HBF4-B	1/2"	1/2"-14 BSPP	Brass
4HBF4-S	1/2"	1/2"-14 BSPP	303 Stainless Steel
4HBF4-SS	1/2"	1/2"-14 BSPP	316 Stainless Steel
6HF6	3/4"	3/4"-14 NPTF	Steel
6HF6-B	3/4"	3/4"-14 NPTF	Brass
6HF6-S	3/4"	3/4"-14 NPTF	303 Stainless Steel
6HF6-SS	3/4"	3/4"-14 NPTF	316 Stainless Steel
6HOF6	3/4"	1 1/16"-12 ORB	Steel
6HOF6-S	3/4"	1 1/16"-12 ORB	303 Stainless Steel
6HOF6-SS	3/4"	1 1/16"-12 ORB	316 Stainless Steel
6HBF6	3/4"	3/4"-14 BSPP	Steel
6HBF6-B	3/4"	3/4"-14 BSPP	Brass
6HBF6-S	3/4"	3/4"-14 BSPP	303 Stainless Steel
6HBF6-SS	3/4"	3/4"-14 BSPP	316 Stainless Steel
8HF8	1"	1"-11 1/2 NPTF	Steel
8HF8-B	1"	1"-11 1/2 NPTF	Brass
8HF8-S	1"	1"-11 1/2 NPTF	303 Stainless Steel
8HF8-SS	1"	1"-11 1/2 NPTF	316 Stainless Steel
8HOF8	1"	1 5/16"-12 ORB	Steel
8HOF8-S	1"	1 5/16"-12 ORB	303 Stainless Steel
8HOF8-SS	1"	1 5/16"-12 ORB	316 Stainless Steel
8HBF8	1"	1"-11 BSPP	Steel
8HBF8-B	1"	1"-11 BSPP	Brass
8HBF8-S	1"	1"-11 BSPP	303 Stainless Steel
8HBF8-SS	1"	1"-11 BSPP	316 Stainless Steel
10HF10	1 1/4"	1 1/4"-11 1/2 NPTF	Steel
10HF10-B	1 1/4"	1 1/4"-11 1/2 NPTF	Brass
10HF10-S	1 1/4"	1 1/4"-11 1/2 NPTF	303 Stainless Steel
10HF10-SS	1 1/4"	1 1/4"-11 1/2 NPTF	316 Stainless Steel
10HBF10	1 1/4"	1 1/4"-11 BSPP	Steel
10HBF10-B	1 1/4"	1 1/4"-11 BSPP	Brass
10HBF10-S	1 1/4"	1 1/4"-11 BSPP	303 Stainless Steel
10HBF10-SS	1 1/4"	1 1/4"-11 BSPP	316 Stainless Steel
12HF10	1 1/2"	1 1/4"-11 1/2 NPTF	Steel
12HF10-B	1 1/2"	1 1/4"-11 1/2 NPTF	Brass
12HF10-S	1 1/2"	1 1/4"-11 1/2 NPTF	306 SS
12HOF10	1 1/2"	1 5/8"-12 ORB	Steel
12HF12	1 1/2"	1 1/2"-11 1/2 NPTF	Steel
12HF12-B	1 1/2"	1 1/2"-11 1/2 NPTF	Brass
12HF12-S	1 1/2"	1 1/2"-11 1/2 NPTF	303 Stainless Steel
12HF12-SS	1 1/2"	1 1/2"-11 1/2 NPTF	316 Stainless Steel
12HOF12	1 1/2"	1 7/8"-12 ORB	Steel
12HBF12	1 1/2"	1 1/2"-11 BSPP	Steel
12HBF12-B	1 1/2"	1 1/2"-11 BSPP	Brass
12HBF12-S	1 1/2"	1 1/2"-11 BSPP	303 Stainless Steel
12HBF12-SS	1 1/2"	1 1/2"-11 BSPP	316 Stainless Steel

## H-SERIES ISO-B INTERCHANGE (NIPPLE)

PART NO.	BODY SIZE	THREAD SIZE	BODY MATERIAL
H1F1	1/8"	1/8"-27 NPTF	Steel
H1F1-B	1/8"	1/8"-27 NPTF	Brass
H1F1-S	1/8"	1/8"-27 NPTF	303 Stainless Steel
H1F1-SS	1/8"	1/8"-27 NPTF	316 Stainless Steel
H1OF2	1/8"	7/16"-20 ORB	Steel
H2F2	1/4"	1/4"-18 NPTF	Steel
H2F2-B	1/4"	1/4"-18 NPTF	Brass
H2F2-S	1/4"	1/4"-18 NPTF	303 Stainless Steel
H2F2-SS	1/4"	1/4"-18 NPTF	316 Stainless Steel
H2OF3	1/4"	9/16"-18 ORB	Steel
H2OF3-S	1/4"	9/16"-18 ORB	303 Stainless Steel
H2OF3-SS	1/4"	9/16"-18 ORB	316 Stainless Steel
H2BF2	1/4"	1/4"-19 BSPP	Steel
H2BF2-B	1/4"	1/4"-19 BSPP	Brass
H2BF2-S	1/4"	1/4"-19 BSPP	303 Stainless Steel
H2BF2-SS	1/4"	1/4"-19 BSPP	316 Stainless Steel
H3F3	3/8"	3/8"-18 NPTF	Steel
H3F3-B	3/8"	3/8"-18 NPTF	Brass
H3F3-S	3/8"	3/8"-18 NPTF	303 Stainless Steel
H3F3-SS	3/8"	3/8"-18 NPTF	316 Stainless Steel
H3OF4	3/8"	3/4"-16 ORB	Steel
H3OF4-S	3/8"	3/4"-16 ORB	303 Stainless Steel
H3OF4-SS	3/8"	3/4"-16 ORB	316 Stainless Steel
H3BF3	3/8"	3/8"-19 BSPP	Steel
H3BF3-B	3/8"	3/8"-19 BSPP	Brass
H3BF3-S	3/8"	3/8"-19 BSPP	303 Stainless Steel
H3BF3-SS	3/8"	3/8"-19 BSPP	316 Stainless Steel
H4F4	1/2"	1/2"-14 NPTF	Steel
H4F4-B	1/2"	1/2"-14 NPTF	Brass
H4F4-S	1/2"	1/2"-14 NPTF	303 Stainless Steel
H4F4-SS	1/2"	1/2"-14 NPTF	316 Stainless Steel
H4OF5	1/2"	7/8"-14 ORB	Steel
H4OF5-S	1/2"	7/8"-14 ORB	303 Stainless Steel
H4OF5-SS	1/2"	7/8"-14 ORB	316 Stainless Steel
H4BF4	1/2"	1/2"-14 BSPP	Steel
H4BF4-B	1/2"	1/2"-14 BSPP	Brass
H4BF4-S	1/2"	1/2"-14 BSPP	303 Stainless Steel
H4BF4-SS	1/2"	1/2"-14 BSPP	316 Stainless Steel
H6F6	3/4"	3/4"-14 NPTF	Steel
H6F6-B	3/4"	3/4"-14 NPTF	Brass
H6F6-S	3/4"	3/4"-14 NPTF	303 Stainless Steel
H6F6-SS	3/4"	3/4"-14 NPTF	316 Stainless Steel
H6OF6	3/4"	1 1/16"-12 ORB	Steel
H6OF6-S	3/4"	1 1/16"-12 ORB	303 Stainless Steel
H6OF6-SS	3/4"	1 1/16"-12 ORB	316 Stainless Steel
H6BF6	3/4"	3/4"-14 BSPP	Steel
H6BF6-B	3/4"	3/4"-14 BSPP	Brass
H6BF6-S	3/4"	3/4"-14 BSPP	303 Stainless Steel
H6BF6-SS	3/4"	3/4"-14 BSPP	316 Stainless Steel
H8F8	1"	1"-11 1/2 NPTF	Steel
H8F8-B	1"	1"-11 1/2 NPTF	Brass
H8F8-S	1"	1"-11 1/2 NPTF	303 Stainless Steel
H8F8-SS	1"	1"-11 1/2 NPTF	316 Stainless Steel
H8OF8	1"	1 5/16"-12 ORB	Steel
H8OF8-S	1"	1 5/16"-12 ORB	303 Stainless Steel
H8OF8-SS	1"	1 5/16"-12 ORB	316 Stainless Steel
H8BF8	1"	1"-11 BSPP	Steel
H8BF8-B	1"	1"-11 BSPP	Brass
H8BF8-S	1"	1"-11 BSPP	303 Stainless Steel
H8BF8-SS	1"	1"-11 BSPP	316 Stainless Steel
H10F10	1 1/4"	1 1/4"-11 1/2 NPTF	Steel
H10F10-B	1 1/4"	1 1/4"-11 1/2 NPTF	Brass
H10F10-S	1 1/4"	1 1/4"-11 1/2 NPTF	303 Stainless Steel
H10F10-SS	1 1/4"	1 1/4"-11 1/2 NPTF	316 Stainless Steel
H10BF10	1 1/4"	1 1/4"-11 BSPP	Steel
H10BF10-B	1 1/4"	1 1/4"-11 BSPP	Brass
H10BF10-S	1 1/4"	1 1/4"-11 BSPP	303 Stainless Steel
H10BF10-SS	1 1/4"	1 1/4"-11 BSPP	316 Stainless Steel
H12F10	1 1/2"	1 1/4"-11 1/2 NPTF	Steel
H12F10-B	1 1/2"	1 1/4"-11 1/2 NPTF	Brass
H12F10-S	1 1/2"	1 1/4"-11 1/2 NPTF	303 Stainless Steel
H12OF10	1 1/2"	1 5/8"-12 ORB	Steel
H12F12	1 1/2"	1 1/2"-11 1/2 NPTF	Steel
H12F12-B	1 1/2"	1 1/2"-11 1/2 NPTF	Brass
H12F12-S	1 1/2"	1 1/2"-11 1/2 NPTF	303 Stainless Steel
H12F12-SS	1 1/2"	1 1/2"-11 1/2 NPTF	316 Stainless Steel
H12OF12	1 1/2"	1 7/8"-12 ORB	Steel
H12BF12	1 1/2"	1 1/2"-11 BSPP	Steel
H12BF12-B	1 1/2"	1 1/2"-11 BSPP	Brass
H12BF12-S	1 1/2"	1 1/2"-11 BSPP	303 Stainless Steel
H12BF12-SS	1 1/2"	1 1/2"-11 BSPP	316 Stainless Steel

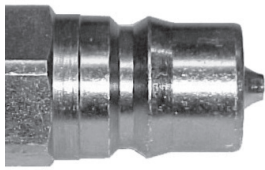

(Female Thread)

## H-Series ISO-B Food Grade Couplings

**B**

- H-Series couplers and nipples are fully compliant with the parameters outlined in ISO7241 Series 'B'
- FKM seals are FDA approved for Food Service applications, such as fryers and fryer-oil filtering equipment
- Large diameter flanged coupler sleeves will prevent damage when dropped and are easier to operate with gloves on
- Couplings are produced in 303 Stainless Steel or 316 Stainless Steel which will fulfil the requirements of various food service applications
- Steel nipples are plated using ROHS Compliant Trivalent Chrome

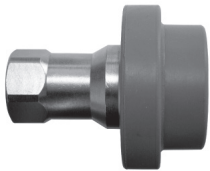

(Female Thread)

### H-SERIES ISO-B FOOD GRADE INTERCHANGE (SILICONE FLANGED COUPLER)

PART NO.	BODY SIZE	THREAD SIZE	BODY MATERIAL
D-4HF4-S-FSB	1/2"	1/2"-14 NPTF	303 Stainless Steel
D-4HF4-SS-FSB	1/2"	1/2"-14 NPTF	316 Stainless Steel

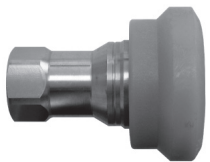

(Female Thread)

### H-SERIES ISO-B FOOD GRADE INTERCHANGE (NYLON FLANGED COUPLER)

PART NO.	BODY SIZE	THREAD SIZE	BODY MATERIAL
D-4HF4-S-FNS	1/2"	1/2"-14 NPTF	303 Stainless Steel
D-4HF4-SS-FNS	1/2"	1/2"-14 NPTF	316 Stainless Steel



(Female Thread)

### H-SERIES ISO-B FOOD GRADE INTERCHANGE (NIPPLE)

PART NO.	BODY SIZE	THREAD SIZE	BODY MATERIAL
D-H4F4-SV-8	1/2"	1/2"-14 NPTF	Steel
D-H4F4-S	1/2"	1/2"-14 NPTF	303 Stainless Steel
D-H4F4-SS	1/2"	1/2"-14 NPTF	316 Stainless Steel

## HS-Series ISO-B Steam Interchange

### Interchange Data:

- Interchangeable to ISO7241 Series 'B'
- Parker 60-Series Steam Couplings

### Materials:

- Machined components are manufactured using solid Steel, Brass, or 303 Stainless Steel bar stock
- Stainless Steel balls, retaining rings, and springs maximise corrosion resistance and extend service life
- Steel componentry is plated using ROHS Compliant Trivalent Chrome
- Large diameter Steel steam-sleeves are hardened to resist deformation and maximise coupler service life
- Steel nipples are hardened to provide heavy duty performance and resist brinelling
- All couplers have a Steel steam-sleeve as standard

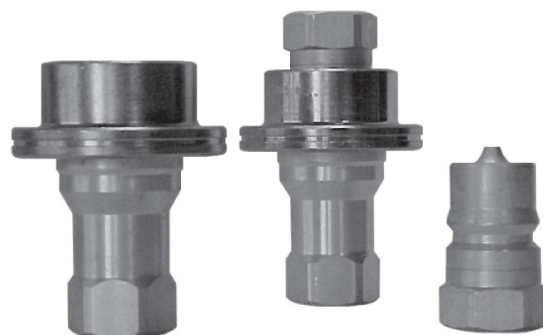

C

### Seal Components:

- EPDM steam-grade seals are standard, providing a temperature range of -57°C to +204°C (-70°F to +400°F)
- Brass couplers have a redundant o-ring sealing system (Dual O-Rings/no PTFE Back-up Ring)
- Stainless couplers have an O-Ring/PTFE Anti-Extrusion ring sealing system
- Valve seals are crimped in place to maintain integrity during excessive flow conditions

### Rated Pressure Chart:

HS-SERIES ISO-B STEAM INTERCHANGE (CONNECTED)																
BODY SIZE	BRASS COUPLER/PLUG				BRASS COUPLER/STEEL PLUG				BRASS COUPLER/303 STAINLESS STEEL PLUG				303 STAINLESS STEEL COUPLER/PLUG			
	Max. Working		Burst		Max. Working		Burst		Max. Working		Burst		Max. Working		Burst	
	PSI	Bar	PSI	Bar	PSI	Bar	PSI	Bar	PSI	Bar	PSI	Bar	PSI	Bar	PSI	Bar
1/4"	200	14	14,500	1,000	200	14	14,500	1,000	200	14	14,500	1,000	200	14	31,500	2,150
3/8"	200	14	12,000	800	200	14	14,500	1,000	200	14	14,500	1,000	200	14	26,500	1,800
1/2"	200	14	11,500	750	200	14	14,500	1,000	200	14	14,500	1,000	200	14	27,500	1,900
3/4"	200	14	9,280	640	200	14	9,280	640	200	14	9,280	640	200	14	16,000	1,100
1"	200	14	5,800	400	200	14	5,800	400	200	14	5,800	400	200	14	15,000	1,000

### Technical Specifications:

BODY SIZE	INTERCHANGE STANDARDS				FUNCTIONAL PARAMETERS				
	U.S. MILITARY	U.S. GOVERNMENT	INTERNATIONAL STANDARDS	ANSI/NFPA STANDARDS	LOCKING BALL QUANTITY	AIR INCLUSION	FLUID LOSS	VACUUM INCH HG	FLOW ΔP = 10 PSI
1/4"	-	-	ISO7241 'B'	B93.113M-B	8	1.1cc	0.9cc	27.4	40kgs/hr
3/8"	-	-	ISO7241 'B'	B93.113M-B	9	2.6cc	1.8cc	27.4	93kg/hr
1/2"	-	-	ISO7241 'B'	B93.113M-B	9	3.8cc	2.9cc	27.4	137kg/hr
3/4"	-	-	ISO7241 'B'	B93.113M-B	12	10.8cc	9.7cc	27.4	257kg/hr
1"	-	-	ISO7241 'B'	B93.113M-B	12	15.9cc	15.3cc	27.4	439kg/hr

Note: Maximum working pressure has been calculated using saturated steam at 194°C (382°F) for general purpose continuous steam service. For advanced operating pressure or super-heated steam applications, contact Dixon for further information.



# Quick Release Couplings

C

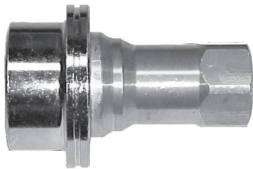

(Female Thread)

## H-SERIES ISO-B STEAM INTERCHANGE COUPLER

PART NO	BODY SIZE	THREAD SIZE	BODY MATERIAL
2HSF2-B	1/4"	1/4" - 18 NPTF	Brass
2HSF2-S	1/4"	1/4" - 18 NPTF	303 Stainless Steel
2HSBF2-B	1/4"	1/4" - 19 BSPP	Brass
2HSBF2-S	1/4"	1/4" - 19 BSPP	303 Stainless Steel
3HSF3-B	3/8"	3/8" - 18 NPTF	Brass
3HSF3-S	3/8"	3/8" - 18 NPTF	303 Stainless Steel
3HSBF3-B	3/8"	3/8" - 19 BSPP	Brass
3HSBF3-S	3/8"	3/8" - 19 BSPP	303 Stainless Steel
4HSF4-B	1/2"	1/2" - 14 NPTF	Brass
4HSF4-S	1/2"	1/2" - 14 NPTF	303 Stainless Steel
4HSBF4-B	1/2"	1/2" - 14 BSPP	Brass
4HSBF4-S	1/2"	1/2" - 14 BSPP	303 Stainless Steel
6HSF6-B	3/4"	3/4" - 14 NPTF	Brass
6HSF6-S	3/4"	3/4" - 14 NPTF	303 Stainless Steel
6HSBF6-B	3/4"	3/4" - 14 BSPP	Brass
6HSBF6-S	3/4"	3/4" - 14 BSPP	303 Stainless Steel
8HSF8-B	1"	1" - 11 1/2" NPTF	Brass
8HSF8-S	1"	1" - 11 1/2" NPTF	303 Stainless Steel
8HSBF8-B	1"	1" - 11 BSPP	Brass
8HSBF8-S	1"	1" - 11 BSPP	303 Stainless Steel

## H-SERIES ISO-B STEAM INTERCHANGE NIPPLE

PART NO	BODY SIZE	THREAD SIZE	BODY MATERIAL
HS2F2	1/4"	1/4" - 18 NPTF	Steel
HS2F2-B	1/4"	1/4" - 18 NPTF	Brass
HS2F2-S	1/4"	1/4" - 18 NPTF	303 Stainless Steel
HS2BF2	1/4"	1/4" - 19 BSPP	Steel
HS2BF2-B	1/4"	1/4" - 19 BSPP	Brass
HS2BF2-S	1/4"	1/4" - 19 BSPP	303 Stainless Steel
HS3F3	3/8"	3/8" - 18 NPTF	Steel
HS3F3-B	3/8"	3/8" - 18 NPTF	Brass
HS3F3-S	3/8"	3/8" - 18 NPTF	303 Stainless Steel
HS3BF3	3/8"	3/8" - 19 BSPP	Steel
HS3BF3-B	3/8"	3/8" - 19 BSPP	Brass
HS3BF3-S	3/8"	3/8" - 19 BSPP	303 Stainless Steel
HS4F4	1/2"	1/2" - 14 NPTF	Steel
HS4F4-B	1/2"	1/2" - 14 NPTF	Brass
HS4F4-S	1/2"	1/2" - 14 NPTF	303 Stainless Steel
HS4BF4	1/2"	1/2" - 14 BSPP	Steel
HS4BF4-B	1/2"	1/2" - 14 BSPP	Brass
HS4BF4-S	1/2"	1/2" - 14 BSPP	303 Stainless Steel
HS6F6	3/4"	3/4" - 14 NPTF	Steel
HS6F6-B	3/4"	3/4" - 14 NPTF	Brass
HS6F6-S	3/4"	3/4" - 14 NPTF	303 Stainless Steel
HS6BF6	3/4"	3/4" - 14 BSPP	Steel
HS6BF6-B	3/4"	3/4" - 14 BSPP	Brass
HS6BF6-S	3/4"	3/4" - 14 BSPP	303 Stainless Steel
HS8F8	1"	1" - 11 1/2" NPTF	Steel
HS8F8-B	1"	1" - 11 1/2" NPTF	Brass
HS8F8-S	1"	1" - 11 1/2" NPTF	303 Stainless Steel
HS8BF8	1"	1" - 11 BSPP	Steel
HS8BF8-B	1"	1" - 11 BSPP	Brass
HS8BF8-S	1"	1" - 11 BSPP	303 Stainless Steel



(Female Thread)

## K-Series ISO7241 Series "A" Interchange

### Interchange Data:

- Interchangeable to ISO7241 Series 'A'
- Parker 6600-Series, Aeroquip/Eaton FD56 (5600)
- Faster ANV, Hansen HA15000, Safeway S56-Series, DNP-PAV 1 Series, Stucchi-BIR series

### Materials:

- Machined components are manufactured using solid Steel bar stock
- Stainless Steel balls, retaining rings, and springs maximise corrosion resistance and extend service life
- Steel componentry is plated using ROHS Compliant Trivalent Chrome
- Steel coupler sleeves are hardened to resist deformation and maximise service life
- Steel nipples are hardened to provide heavy duty performance



### Seal Components:

- Nitrile (Buna-N) seals are standard, providing a temperature range of -40°C (-40°F) to +121°C (250°F)
- Couplers have a PTFE Anti-Extrusion ring
- Valve seals are crimped in place to maintain integrity during excessive flow conditions and pressurised connection

### Rated Pressure Chart:

K-SERIES ISO-A INTERCHANGE (CONNECTED)				
BODY SIZE	STEEL COUPLER/PLUG			
	MAX. WORKING		BURST	
	PSI	Bar	PSI	Bar
1/4"	5,000	345	18,270	1,200
3/8"	4,000	275	18,270	1,200
1/2"	4,000	275	16,500	1,100
3/4"	4,000	275	14,800	1,000
1"	4,000	275	12,400	850
1 1/4"	3,000	200	12,600	850
1 1/2"	3,000	200	12,600	850
2"	1,450	100	5,800	400

### Technical Specifications:

BODY SIZE	INTERCHANGE STANDARDS				FUNCTIONAL PARAMETERS				
	U.S. MILITARY	U.S. GOVERNMENT	INTERNATIONAL STANDARDS	ANSI/NFPA STANDARDS	LOCKING BALL QUANTITY	AIR INCLUSION	FLUID LOSS	VACUUM INCH HG	FLOW ΔP = 22 PSI L/MIN
1/4"	-	-	ISO7241 'A'	B93.113M-A	6	0.6cc	0.3cc	26.5	11
3/8"	-	-	ISO7241 'A'	B93.113M-A	9	2.6cc	1.8cc	26.5	26
1/2"	-	-	ISO7241 'A'	B93.113M-A	9	3.8cc	2.9cc	26.5	45
3/4"	-	-	ISO7241 'A'	B93.113M-A	12	10.8cc	9.7cc	26.5	109
1"	-	-	ISO7241 'A'	B93.113M-A	15	15.9cc	15.3cc	26.5	188
1 1/4"	-	-	ISO7241 'A'	B93.113M-A	16	31.7cc	29.1cc	26.5	263
1 1/2"	-	-	ISO7241 'A'	B93.113M-A	16	56.4cc	52.2cc	26.5	338
2"	-	-	ISO7241 'A'	B93.113M-A	15	N/A	N/A	26.5	451

# Quick Release Couplings

D

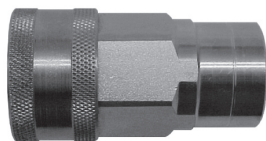

(Female Thread)

## K-SERIES ISO-A INTERCHANGE (COUPLER)

PART NO.	BODY SIZE	THREAD SIZE	BODY MATERIAL
2KF1	1/4"	1/8"-27 NPTF	Steel
2KF2	1/4"	1/4"-18 NPTF	Steel
2KBF2	1/4"	1/4"-19 BSPP	Steel
2KOF2	1/4"	7/16"-20 ORB	Steel
3KF3	3/8"	3/8"-18 NPTF	Steel
3KOF3	3/8"	9/16"-18 ORB	Steel
3KBF3	3/8"	3/8"-19 BSPP	Steel
4KF4	1/2"	1/2"-14 NPTF	Steel
4KOF4	1/2"	3/4"-16 ORB	Steel
4KBF4	1/2"	1/2"-14 BSPP	Steel
4KOF5	1/2"	7/8"-14 ORB	Steel
4KF6	1/2"	3/4"-14 NPTF	Steel
4KBF6	1/2"	1/2"-14 BSPP	Steel
6KF6	3/4"	3/4"-14 NPTF	Steel
6KOF6	3/4"	1-1/6"-12 ORB	Steel
6KBF6	3/4"	3/4"-14 BSPP	Steel
8KF8	1"	1"-11 1/2 NPTF	Steel
8KOF8	1"	1 5/16"-12 ORB	Steel
8KBF8	1"	1"-11 BSPP	Steel
10KF10	1 1/4"	1 1/4"-11 1/2 NPTF	Steel
10KBF10	1 1/4"	1 1/4"-11 BSPP	Steel
12KF12	1 1/2"	1 1/2"-11 1/2 NPTF	Steel
12KBF12	1 1/2"	1 1/2"-11 BSPP	Steel
16KF16	2"	2"-11 1/2 NPTF	Steel
16KBF16	2"	2"-11 BSPP	Steel

## K-SERIES ISO-A INTERCHANGE (NIPPLE)

PART NO.	BODY SIZE	THREAD SIZE	BODY MATERIAL
K2F1	1/4"	1/8-27 NPTF	Steel
K2F2	1/4"	1/4"-18 NPTF	Steel
K2BF2	1/4"	1/4"-19 BSPP	Steel
K2OF2	1/4"	7/16"-20 ORB	Steel
K3F3	3/8"	3/8"-18 NPTF	Steel
K3OF3	3/8"	9/16"-18 ORB	Steel
K3BF3	3/8"	3/8"-19 BSPP	Steel
K4F4	1/2"	1/2"-14 NPTF	Steel
K4OF4	1/2"	3/4"-16 ORB	Steel
K4BF4	1/2"	1/2"-14 BSPP	Steel
K4OF5	1/2"	7/8"-14 ORB	Steel
K4F6	1/2"	3/4"-14 NPTF	Steel
K4BF6	1/2"	1/2"-14 BSPP	Steel
K6F6	3/4"	3/4"-14 NPTF	Steel
K6OF6	3/4"	1 1/6"-12 ORB	Steel
K6BF6	3/4"	3/4"-14 BSPP	Steel
K8F8	1"	1"-11 1/2 NPTF	Steel
K8OF8	1"	1 5/16"-12 ORB	Steel
K8BF8	1"	1"-11 BSPP	Steel
K10F10	1 1/4"	1 1/4"-11 1/2 NPTF	Steel
K10BF10	1 1/4"	1 1/4"-11 BSPP	Steel
K12F12	1 1/2"	1 1/2"-11 1/2 NPTF	Steel
K12BF12	1 1/2"	1 1/2"-11 BSPP	Steel
K16F16	2"	2"-11 1/2 NPTF	Steel
K16BF16	2"	2"-11 BSPP	Steel

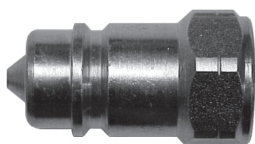

(Female Thread)





## K-SERIES ISO-A INTERCHANGE COLOUR CODED DUST PLUG

PART NO	BODY SIZE	COLOUR	MATERIAL
4KDP	1/2"	Black	Nitrile
4K-R-DP	1/2"	Red	Nitrile
4K-O-DP	1/2"	Orange	Nitrile
4K-Y-DP	1/2"	Yellow	Nitrile
4K-G-DP	1/2"	Green	Nitrile
4K-B-DP	1/2"	Blue	Nitrile

D



## K-SERIES ISO-A INTERCHANGE COLOUR CODED DUST CAP

PART NO	BODY SIZE	COLOUR	MATERIAL
K4DC	1/2"	Black	Nitrile
K4-R-DC	1/2"	Red	Nitrile
K4-O-DC	1/2"	Orange	Nitrile
K4-Y-DC	1/2"	Yellow	Nitrile
K4-G-DC	1/2"	Green	Nitrile
K4-B-DC	1/2"	Blue	Nitrile



## K-SERIES ISO-A INTERCHANGE COMBINATION DUST CAP AND PLUG

PART NO	BODY SIZE	MATERIAL
2KDP-K2DC	1/4"	Nitrile
3KDP-K3DC	3/8"	Nitrile
See Above	1/2"	Nitrile
6KDP-K6DC	3/4"	Nitrile
8KDP-K8DC	1"	Nitrile

## AG-Series Hydraulic Couplings

### Interchange Data:

- Pioneer Agricultural Interchange
- Parker/Pioneer 4000 Series, Faster NS/NV-Series
- Safeway Series-S20, Stucchi IR-Series, Snap-Tite 60-Series



### Materials:

- Machined components are manufactured using solid Steel bar stock
- Stainless Steel balls, retaining rings, and springs maximise corrosion resistance and extend service life
- Steel componentry is plated using ROHS Compliant Trivalent Chrome
- Steel coupler sleeves are hardened to resist deformation and maximise service life
- Steel nipples are hardened to provide heavy duty performance and resist brinelling

### Seal Components:

- Nitrile (Buna-N) seals are standard, providing a temperature range of -40°C to +121°C (-40°F to +250°F)
- Couplers have a PTFE Anti-Extrusion ring
- Poppet valve seals are crimped in place to maintain integrity during excessive flow conditions and pressurised connection
- Piloted ball valve has a seal that is crimped to prevent low-pressure leakage

### Rated Pressure Chart:

AG-SERIES AGRICULTURAL INTERCHANGE (CONNECTED)								
BODY SIZE	BALL STEEL COUPLER/PLUG				POPPET STEEL COUPLER/PLUG			
	Maximum Working		Burst		Maximum Working		Burst	
	PSI	Bar	PSI	Bar	PSI	Bar	PSI	Bar
1/4"	4,000	275	24,400	1,700	4,000	275	21,000	1,500
3/8"	4,000	275	25,000	1,700	4,000	275	23,100	1,600
1/2"	4,000	275	16,500	1,100	4,000	275	16,500	1,100
3/4"	3,000	200	15,800	1,050	3,000	200	10,300	700
1"	3,000	200	13,500	900	3,000	200	13,000	900

### Technical Specifications:

BODY SIZE	INTERCHANGE STANDARDS				FUNCTIONAL PARAMETERS				
	U.S. MILITARY	U.S. GOVERNMENT	INTERNATIONAL STANDARDS	ANSI/NFPA STANDARDS	LOCKING BALL QUANTITY	AIR INCLUSION	FLUID LOSS	VACUUM INCH HG	FLOW $\Delta P = 22$ PSI L/MIN
1/4"	-	-	-	-	8	1.1cc	0.9cc	26.5	15
3/8"	-	-	-	-	9	2.6cc	1.8cc	26.5	23
1/2"	-	-	ISO7241 'A'	-	9	3.8cc	2.9cc	26.5	45
3/4"	-	-	ISO5675	-	12	10.8cc	9.7cc	26.5	102
1"	-	-	-	-	12	15.9cc	15.3cc	26.5	180



AG-SERIES AGRICULTURAL INTERCHANGE (COUPLER DUST PLUG)			
PART NO.	BODY SIZE	CAP LANYARD	BODY MATERIAL
2AGDP	1/4"	Elastomer	Elastomer
3AGDP	3/8"	Elastomer	Elastomer
4AGDP*	1/2"	Elastomer	Elastomer
6AGDP	3/4"	Elastomer	Elastomer
8AGDP	1"	Elastomer	Elastomer

\* For the 1/2" please refer to the colour coded K Series Dust Caps and Dust Plugs on Page 16



AG-SERIES AGRICULTURAL INTERCHANGE (NIPPLE DUST CAP)			
PART NO.	BODY SIZE	CAP LANYARD	BODY MATERIAL
AG2DC	1/4"	Elastomer	Elastomer
AG3DC	3/8"	Elastomer	Elastomer
AG4DC*	1/2"	Elastomer	Elastomer
AG6DC	3/4"	Elastomer	Elastomer
AG8DC	1"	Elastomer	Elastomer

\* For the 1/2" please refer to the colour coded K Series Dust Caps and Dust Plugs on Page 16

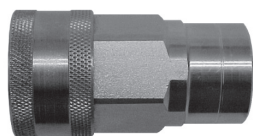

(Female Thread)

AG-SERIES AGRICULTURAL INTERCHANGE (COUPLER)			
PART NO.	BODY SIZE	THREAD SIZE	BODY MATERIAL
2AGF2	1/4"	1/4"-18 NPTF	Steel
2AGF2-PV	1/4"	1/4"-18 NPTF	Steel
3AGF3	3/8"	3/8"-18 NPTF	Steel
3AGF3-PV	3/8"	3/8"-18 NPTF	Steel
4AGF4	1/2"	1/2"-14 NPTF	Steel
4AGF4-PV	1/2"	1/2"-14 NPTF	Steel
4AGBF4	1/2"	1/2"-14 BSPP	Steel
4AGBF4-PV	1/2"	1/2"-14 BSPP	Steel
4AGOF4	1/2"	3/4"-16 ORB	Steel
4AGOF4-PV	1/2"	3/4"-16 ORB	Steel
4AGOF5	1/2"	7/8"-14 ORB	Steel
4AGOF5-PV	1/2"	7/8"-14 ORB	Steel
4AGF6	1/2"	3/4"-14 NPTF	Steel
4AGF6-PV	1/2"	3/4"-14 NPTF	Steel
4AGBF6	1/2"	3/4"-14 BSPP	Steel
4AGBF6-PV	1/2"	3/4"-14 BSPP	Steel
6AGF6	3/4"	3/4"-14 NPTF	Steel
6AGF6-PV	3/4"	3/4"-14 NPTF	Steel
8AGF8	1"	1"-11 1/2 NPTF	Steel
8AGF8-PV	1"	1"-11 1/2 NPTF	Steel

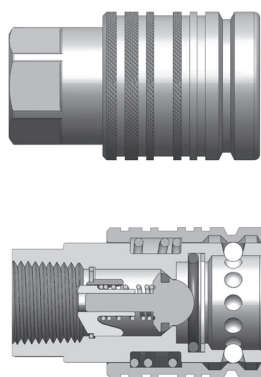

AG-SERIES AGRICULTURAL PUSH-PULL BALL VALVE COUPLER (FEMALE THREADS)			
PART NO	BODY SIZE	THREADS	MATERIAL
4AGF4-PS	1/2"	1/2" - 14 NPTF	Steel
4AGOF4-PS	1/2"	3/4" - 16 ORB	Steel
4AGOF5-PS	1/2"	7/8" - 14 ORB	Steel
4AGF6-PS	1/2"	3/4" - 14 NPTF	Steel

# Quick Release Couplings

E

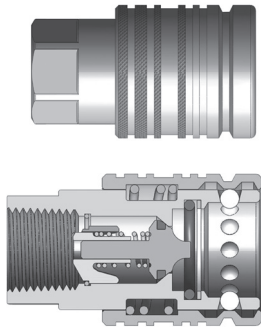

## AG-SERIES AGRICULTURAL PUSH-PULL POPPET VALVE COUPLER (FEMALE THREADS)

PART NO	BODY SIZE	THREADS	MATERIAL
4AGF4-PV-PS	1/2"	1/2" - 14 NPTF	Steel
4AGOF4-PV-PS	1/2"	3/4" - 16 ORB	Steel
4AGOF5-PV-PS	1/2"	7/8" - 14 ORB	Steel
4AGF6-PV-PS	1/2"	3/4" - 14 NPTF	Steel

## AG-SERIES AGRICULTURAL INTERCHANGE (NIPPLE)

PART NO.	BODY SIZE	THREAD SIZE	BODY MATERIAL
AG2F2	1/4"	1/4"-18 NPTF	Steel
AG2F2-PV	1/4"	1/4"-18 NPTF	Steel
AG3F3	3/8"	3/8"-18 NPTF	Steel
AG3F3-PV	3/8"	3/8"-18 NPTF	Steel
AG4F4	1/2"	1/2"-14 NPTF	Steel
AG4F4-PV	1/2"	1/2"-14 NPTF	Steel
AG4BF4	1/2"	1/2"-14 BSPP	Steel
AG4BF4-PV	1/2"	1/2"-14 BSPP	Steel
AG4OF4	1/2"	3/4"-16 ORB	Steel
AG4OF4-PV	1/2"	3/4"-16 ORB	Steel
AG4OF5	1/2"	7/8"-14 ORB	Steel
AG4OF5-PV	1/2"	7/8"-14 ORB	Steel
AG4F6	1/2"	3/4"-14 NPTF	Steel
AG4F6-PV	1/2"	3/4"-14 NPTF	Steel
AG4BF6	1/2"	3/4"-14 BSPP	Steel
AG4BF6-PV	1/2"	3/4"-14 BSPP	Steel
AG6F6	3/4"	3/4"-14 NPTF	Steel
AG6F6-PV	3/4"	3/4"-14 NPTF	Steel
AG8F8	1"	1"-11 1/2 NPTF	Steel
AG8F8-PV	1"	1"-11 1/2 NPTF	Steel

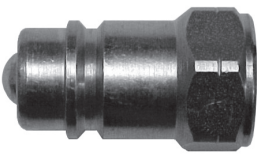

(Female Thread)

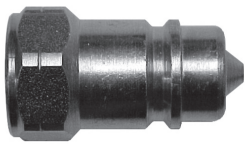

Poppet Valve Style (-PV)

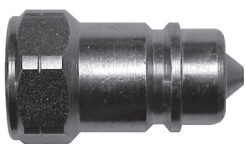

Poppet Valve Style (-PV)

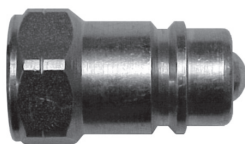

Standard Ball Valve Style

Dixon carries two valve styles for the Agricultural coupling series, 'Ball' valve and 'Poppet' valve. The 'Ball' valve coupling has historically provided greater longevity while the 'Poppet' valve will improve flow while in operation.

## VEP-Series Threaded Flushface Interchange

Two-stage valving to protect critical sealing components during pressurised connection & disconnection

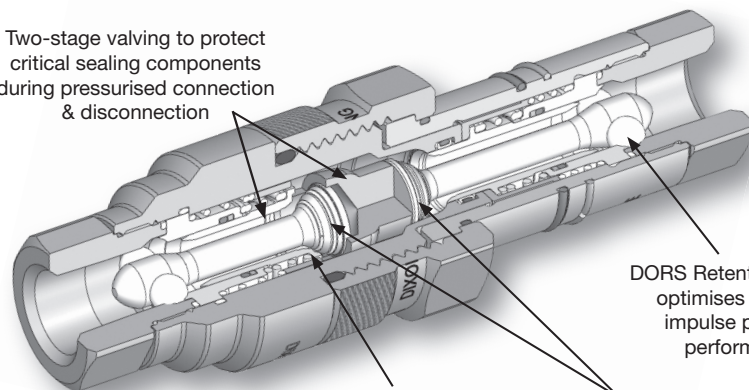

Posi-Lock valve system secures valving during surge-flow conditions to prevent high-velocity damage

DORS Retention System optimises flow and impulse pressure performance

High performance stem seals constructed of Acetal or Polyurethane



F

### Features:

- Fully Interchangeable with Stucchi VEP-P/VEP-HD Series, DNP PST4 Series, Voswinkel FT Series, Holmbury HFT Series and Parker FET-Series
- Available with NPTF, BSPP, ORB and Optional Code 62 Connections
- Improved Connect and Disconnect Performance Up To 5,500psi (380 Bar)
- Patented Valve Mechanism Optimises Flow and Pressure Performance
- Improved Corrosion Resistance Using ROHS Compliant Zinc Nickel Plating
- Temperature Range: -30°C to +100°C (-22°F to +212°F)

### Technical Specifications

Body Size	Pressure Rating				Burst Pressure						Max. Pressure Connect <sup>3</sup>		Max. Pressure Disconnect <sup>3</sup>		Rated Flow ΔP=21.75psi
	ISO Working <sup>1</sup>		Max. Impulse <sup>2</sup>		Connected		Coupler		Plug		psi	Bar	psi	Bar	L/min
	psi	Bar	psi	Bar	psi	Bar	psi	Bar	psi	Bar	psi	Bar	psi	Bar	
1/4"	6,000	400	9,000	620	24,000	1650	22,000	1520	22,000	1520	5,500	380	5,500	380	13
3/8"	5,500	380	8,000	550	22,000	1520	18,000	1240	20,000	1380	4,500	310	4,500	310	40
1/2"	5,500	380	8,000	550	22,000	1520	18,000	1240	20,000	1380	4,500	310	4,500	310	66
3/4"	5,500	380	8,000	550	22,000	1520	18,000	1240	20,000	1380	4,500	310	4,500	310	85
1"	5,500	380	7,500	520	22,000	1520	14,500	1000	20,000	1380	3,625	250	3,625	250	123
1 1/4"	5,000	350	7,000	480	20,000	1380	14,500	1000	16,000	1100	3,625	250	3,625	250	174
1 1/2"	4,500	310	5,800	400	18,000	1240	12,000	830	14,500	1000	3,000	210	3,000	210	360
2"	4,000	280	5,000	350	18,000	1240	12,000	830	14,500	1000	3,000	210	3,000	210	653

<sup>1</sup> Couplings Impulse tested in accordance with ISO7241-2 for 1,000,000 cycles connected and 100,000 cycles disconnected at 133% of ISO Working Pressure.

<sup>2</sup> Couplings Impulse tested in accordance with ISO7241-2 for 100,000 cycles connected and disconnected at Maximum Impulse pressure listed.

<sup>3</sup> System temperature for Maximum Connect/Disconnect Pressure must not exceed 65°C (150°F).

### How to Connect & Disconnect the VEP-Series Coupling

1. Prior to connecting, thoroughly clean all mating surfaces and threads on both halves, then pull the coupler sleeve forward.
2. To initiate the connection, align the coupler and plug, pushing/turning the coupler sleeve towards the plug while engaging the threads.
3. Allow the threads to pull the coupler onto the plug, do not push the coupler onto the plug.
4. The first phase of the connection should be threaded by hand, without the use of tools.
5. The second phase of the connection may require a wrench if the pressure is higher than anticipated.
6. Continue to thread the coupler sleeve onto the plug until the end of the sleeve meets the plug body
7. To disconnect, use a wrench to break the coupler sleeve free and keep the mating halves aligned during the disconnection process.

# Quick Release Couplings

F

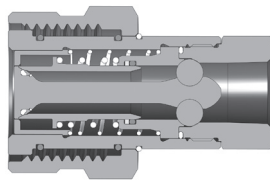
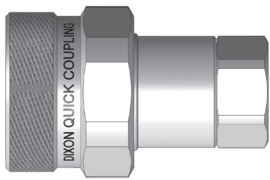

## VEP SERIES THREADED FLUSHFACE (COUPLER)

PART NO.	SIZE	THREAD	LENGTH		MAXIMUM OD		WEIGHT KG.	HEX MM
			in	mm	in	mm		
2VEPF2	1/4"	1/4" - 18 NPTF	2.14	54.4	1.49	37.8	0.22	20
2VEPBF2	1/4"	1/4" - 19 BSPP	2.14	54.4	1.49	37.8	0.22	20
3VEPF3	3/8"	3/8" - 18 NPTF	2.55	64.8	1.62	41.1	0.29	20
3VEPBF3	3/8"	3/8" - 19 BSPP	2.55	64.8	1.62	41.1	0.29	20
3VEPF4	3/8"	1/2" - 14 NPTF	2.77	70.4	1.62	41.1	0.30	20
3VEPBF4	3/8"	1/2" - 14 BSPP	2.77	70.4	1.62	41.1	0.30	20
4VEPF4	1/2"	1/2" - 14 NPTF	3.08	78.2	1.98	50.3	0.62	15
4VEPBF4	1/2"	1/2" - 14 BSPP	3.08	78.2	1.98	50.3	0.62	15
4VEPF6	1/2"	3/4" - 14 NPTF	3.38	85.9	1.98	50.3	0.71	15
4VEPBF6	1/2"	3/4" - 14 BSPP	3.38	85.9	1.98	50.3	0.71	15
6VEPF6	3/4"	3/4" - 14 NPTF	3.37	85.6	2.19	55.6	0.77	1
6VEPBF6	3/4"	3/4" - 14 BSPP	3.37	85.6	2.19	55.6	0.77	1
8VEPF8	1"	1" - 11 1/2 NPTF	3.89	98.8	2.46	62.5	1.11	1
8VEPBF8	1"	1" - 11 BSPP	3.89	98.8	2.46	62.5	1.11	1
10VEPF10	1 1/4"	1 1/4" - 11 1/2 NPTF	4.40	111.8	2.70	68.6	1.71	1
10VEPBF10	1 1/4"	1 1/4" - 11 BSPP	4.40	111.8	2.70	68.6	1.71	1
12VEPF12	1 1/2"	1 1/2" - 11 1/2 NPTF	5.28	134.1	3.74	95.0	4.12	1
12VEPBF12	1 1/2"	1 1/2" - 11 BSPP	5.28	134.1	3.74	95.0	4.12	1
16VEPF16	2"	2" - 11 1/2 NPTF	9.42	239.3	7.39	187.7	15.22	1
16VEPBF16	2"	2" - 11 BSPP	9.42	239.3	7.39	187.7	15.22	1

## VEP SERIES THREADED FLUSHFACE (NIPPLE)

PART NO.	SIZE	THREAD	LENGTH		MAXIMUM OD		WEIGHT KG.	HEX MM
			in	mm	in	mm		
VEP2F2	1/4"	1/4" - 18 NPTF	2.67	67.8	1.35	34.3	0.24	20
VEP2BF2	1/4"	1/4" - 19 BSPP	2.67	67.8	1.35	34.3	0.24	20
VEP3F3	3/8"	3/8" - 18 NPTF	3.28	83.3	1.48	37.6	0.34	20
VEP3BF3	3/8"	3/8" - 19 BSPP	3.28	83.3	1.48	37.6	0.34	20
VEP3F4	3/8"	1/2" - 14 NPTF	3.50	88.9	1.48	37.6	0.35	20
VEP3BF4	3/8"	1/2" - 14 BSPP	3.50	88.9	1.48	37.6	0.35	20
VEP4F4	1/2"	1/2" - 14 NPTF	3.87	98.3	1.86	47.2	0.59	10
VEP4BF4	1/2"	1/2" - 14 BSPP	3.87	98.3	1.86	47.2	0.59	10
VEP4F6	1/2"	3/4" - 14 NPTF	4.07	103.4	1.86	47.2	0.68	10
VEP4BF6	1/2"	3/4" - 14 BSPP	4.07	103.4	1.86	47.2	0.68	10
VEP6F6	3/4"	3/4" - 14 NPTF	4.12	104.6	1.98	50.3	0.83	1
VEP6BF6	3/4"	3/4" - 14 BSPP	4.12	104.6	1.98	50.3	0.83	1
VEP8F8	1"	1" - 11 1/2 NPTF	4.95	125.7	2.20	55.9	1.20	1
VEP8BF8	1"	1" - 11 BSPP	4.95	125.7	2.20	55.9	1.20	1
VEP10F10	1 1/4"	1 1/4" - 11 1/2 NPTF	5.43	137.9	2.73	69.3	1.44	1
VEP10BF10	1 1/4"	1 1/4" - 11 BSPP	5.43	137.9	2.73	69.3	1.44	1
VEP12F12	1 1/2"	1 1/2" - 11 1/2 NPTF	6.63	168.4	3.74	95.0	4.09	1
VEP12BF12	1 1/2"	1 1/2" - 11 BSPP	6.63	168.4	3.74	95.0	4.09	1
VEP16F16	2"	2" - 11 1/2 NPTF	11.08	281.4	5.70	144.8	12.86	1
VEP16BF16	2"	2" - 11 BSPP	11.08	281.4	5.70	144.8	12.86	1

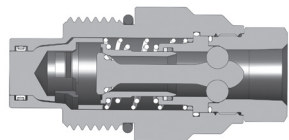
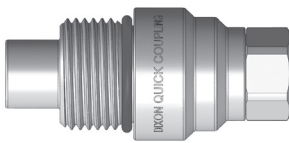

## VEP SERIES THREADED FLUSHFACE (DUST CAP)

PART NO.	SIZE	MATERIAL
VEP2DC-A	1/4"	Aluminium
VEP3DC-A	3/8"	Aluminium
VEP4DC-A	1/2"	Aluminium
VEP6DC-A	3/4"	Aluminium
VEP8DC-A	1"	Aluminium
VEP10DC-A	1 1/4"	Aluminium
VEP12DC-A	1 1/2"	Aluminium
VEP16DC-A	2"	Aluminium

## VEP SERIES THREADED FLUSHFACE (DUST PLUG)

PART NO.	SIZE	MATERIAL
2VEPDP-A	1/4"	Aluminium
3VEPDP-A	3/8"	Aluminium
4VEPDP-A	1/2"	Aluminium
6VEPDP-A	3/4"	Aluminium
8VEPDP-A	1"	Aluminium
10VEPDP-A	1 1/4"	Aluminium
12VEPDP-A	1 1/2"	Aluminium
16VEPDP-A	2"	Aluminium

## TR-Series TEMA European Interchange

### Interchange Data:

- TEMA European Interchange
- TEMA 3800, 5000, 7500, 10000 Series
- CEJN Series 525

### Materials:

- Machined components are manufactured using solid Steel bar stock
- Stainless Steel balls, retaining rings, and springs maximise corrosion resistance and extend service life
- Steel componentry is plated using ROHS Compliant Trivalent Chrome
- Steel coupler sleeves are hardened to resist deformation and maximise service life
- Steel nipples are hardened to provide heavy duty performance



### Seal Components:

- Nitrile (Buna-N) seals are standard, providing a temperature range of -40°C to +121°C (-40°F to +250°F)
- Couplers have a redundant O-Ring sealing system (dual O-Rings with inner PTFE back-up ring)
- Valve seals are crimped in place to maintain integrity during excessive flow conditions and pressurised connection

G

### Rated Pressure Chart:

TR-SERIES TEMA EUROPEAN INTERCHANGE (CONNECTED)				
BODY SIZE	STEEL COUPLER/PLUG			
	MAX. WORKING		BURST	
	PSI	Bar	PSI	Bar
3/8"	5,000	345	20,000	1,400
1/2"	4,000	275	16,500	1,100
3/4"	4,000	275	15,400	1,000
1"	3,200	220	12,800	900

### Technical Specifications:

BODY SIZE	INTERCHANGE STANDARDS				FUNCTIONAL PARAMETERS				
	U.S. MILITARY	U.S. GOVERNMENT	INTERNATIONAL STANDARDS	ANSI/NFPA STANDARDS	LOCKING BALL QUANTITY	AIR INCLUSION	FLUID LOSS	VACUUM INCH HG	FLOW ΔP = 22 PSI L/MIN
3/8"	-	-	-	-	9	2.8cc	1.9cc	28	38
1/2"	-	-	-	-	9	3.9cc	3.1cc	28	56
3/4"	-	-	-	-	9	10.5cc	10.1cc	28	98
1"	-	-	-	-	9	14.7cc	14.2cc	28	135

# Quick Release Couplings

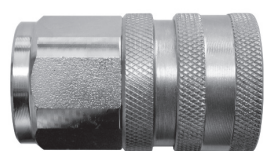

(Female Thread)

## TR-SERIES TEMA EUROPEAN INTERCHANGE (COUPLER)

PART NO.	BODY SIZE	THREAD SIZE	BODY MATERIAL
3TRF3	3/8"	3/8"-18 NPTF	Steel
3TRBF3	3/8"	3/8"-19 BSPP	Steel
4TRF4	1/2"	1/2"-14 NPTF	Steel
4TRBF4	1/2"	1/2"-14 BSPP	Steel
6TRF6	3/4"	3/4"-14 NPTF	Steel
6TRBF6	3/4"	3/4"-14 BSPP	Steel
8TRF8	1"	1"-11 1/2 NPTF	Steel
8TRBF8	1"	1"-11 BSPP	Steel

G

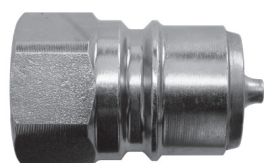

(Female Thread)

## TR-SERIES TEMA EUROPEAN INTERCHANGE (NIPPLE)

PART NO.	BODY SIZE	THREAD SIZE	BODY MATERIAL
TR3F3	3/8"	3/8"-18 NPTF	Steel
TR3BF3	3/8"	3/8"-19 BSPP	Steel
TR4F4	1/2"	1/2"-14 NPTF	Steel
TR4BF4	1/2"	1/2"-14 BSPP	Steel
TR6F6	3/4"	3/4"-14 NPTF	Steel
TR6BF6	3/4"	3/4"-14 BSPP	Steel
TR8F8	1"	1"-11 1/2 NPTF	Steel
TR8BF8	1"	1"-11 BSPP	Steel



## W Series Wing Style Interchange

### Interchange Data:

- Aeroquip 5100-Series, Parker 6100-Series
- Snap-Tite 78-Series, Faster Series-FB, Safeway S51-Series

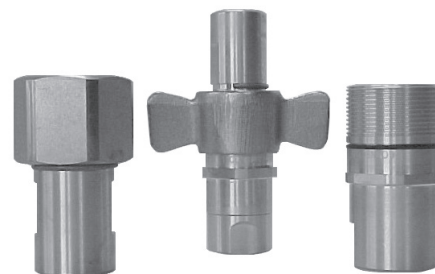

### Materials:

- Machined components are manufactured using solid Steel and Brass bar stock
- Stainless Steel retaining rings, and springs maximise corrosion resistance and extend service life
- Steel componentry is plated using ROHS Compliant Trivalent Chrome
- Rugged Steel wing nut for threaded connect and disconnect operation
- For Steel models, coupler valve sleeve and nipple valve are constructed of Brass

### Seal Components:

- Nitrile (Buna-N) seals are standard, providing a temperature range of -40°C to +121°C (-40°F to +250°F)
- Couplings have a TPC-ET back-up ring on the valve sleeve to extend service life
- Main coupler valve has a bonded face-seal to improve seal integrity during pressurised connection/disconnection
- Nipple valve seal is crimped to improve seal integrity and prolong service life
- External O-Ring on plug indicates full connection and acts as a contamination shield in connected mode
- Redundant O-Ring on the coupler body will engage nipple for secondary sealing support.

H

### Rated Pressure Chart:

W-SERIES WINGSTYLE INTERCHANGE (CONNECTED)				
BODY SIZE	STEEL COUPLER/PLUG			
	MAX. WORKING		BURST	
	PSI	Bar	PSI	Bar
3/4"	3,000	207	13,000	897
1"	4,000	276	16,000	1,103
1 1/4"	3,000	207	12,000	828
1 1/2"	2,500	172	10,000	690

### Technical Specifications:

BODY SIZE	INTERCHANGE STANDARDS				FUNCTIONAL PARAMETERS				
	U.S. MILITARY	U.S. GOVERNMENT	INTERNATIONAL STANDARDS	ANSI/NFPA STANDARDS	LOCKING BALL QUANTITY	AIR INCLUSION	FLUID LOSS	VACUUM INCH HG	FLOW $\Delta P = 22 \text{ PSI}$ L/MIN
3/4"	-	-	-	-	Threaded	0.34cc	0.26cc	27.4	117
1"	-	-	-	-	Threaded	0.50cc	0.35cc	27.4	192
1 1/4"	-	-	-	-	Threaded	0.68cc	0.70cc	27.4	320
1 1/2"	-	-	-	-	Threaded	0.60cc	0.94cc	27.4	414

\*\*Impulse Testing conducted in accordance with ISO7241-2 at 133% of Working Pressure for 1,000,000 cycles both connected and disconnected.

Although the wingstyle couplings are able to connect and disconnect while under pressure, it is recommended that hydraulic power supply be de-energised during connection to ensure operator safety. If it is not possible to de-energize the circuit, operators must be aware of their surroundings to ensure that an attachment or tool does not put them at risk, once hydraulic power is applied during the connection process.

W-Series couplings are not recommended for continuous hydraulic impulse applications at rated pressure



## W-Series Hydraulic Couplings

### Wingstyle Socket Features

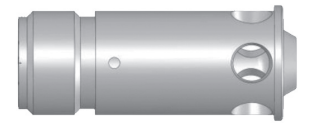
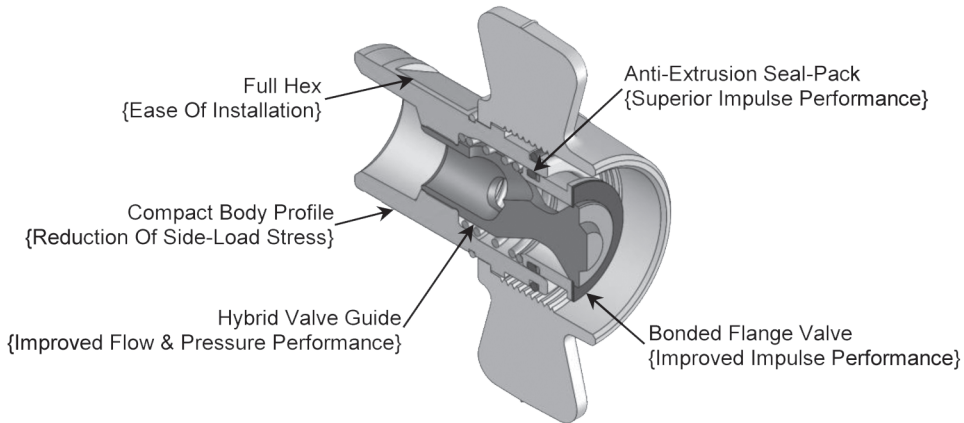

Industry 'Norm' Tubular Valve Guide  
Versus  
Hybrid Valve Guide



### Wingstyle Plug Features

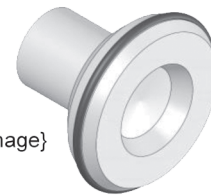
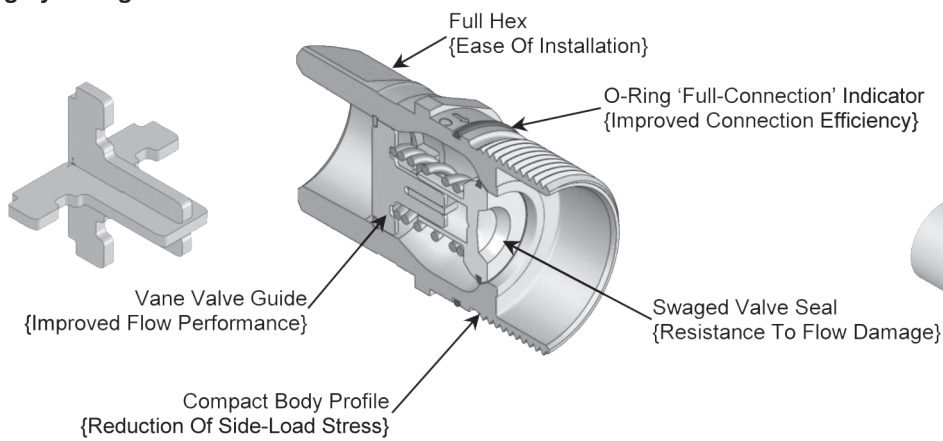

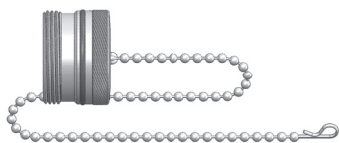

## W-SERIES THREAD-TOGETHER INTERCHANGE (COUPLER RIGID DUST PLUG)

PART NO.	BODY SIZE	CAP LANYARD	BODY MATERIAL
6WDP	3/4"	SS Bead Chain	Steel
8WDP	1"	SS Bead Chain	Steel
10WDP	1 1/4"	SS Bead Chain	Steel
12WDP	1 1/2"	SS Bead Chain	Steel

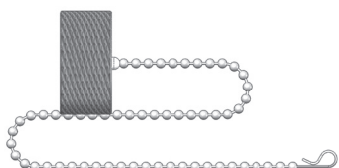

## W-SERIES THREAD-TOGETHER INTERCHANGE (NIPPLE RIGID DUST CAP)

PART NO.	BODY SIZE	CAP LANYARD	BODY MATERIAL
W6DC	3/4"	SS Bead Chain	Steel
W8DC	1"	SS Bead Chain	Steel
W10DC	1 1/4"	SS Bead Chain	Steel
W12DC	1 1/2"	SS Bead Chain	Steel



## W-SERIES THREAD-TOGETHER INTERCHANGE (MOUNTING FLANGE)

PART NO.	BODY SIZE	BOLT HOLE-SIZE	BODY MATERIAL
W6-BMF	3/4"	0.201	Steel
W8-BMF	1"	0.201	Steel
W10-BMF	1 1/4"	0.201	Steel
W12-BMF	1 1/2"	0.201	Steel

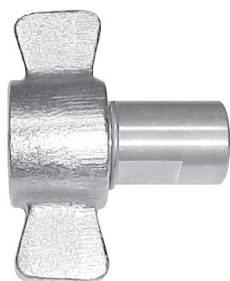

(Female Thread)

## W-SERIES THREAD-TOGETHER INTERCHANGE (WING-NUT COUPLER)

PART NO.	BODY SIZE	THREAD SIZE	BODY MATERIAL
6WBF4-B	3/4"	1/2"-14 BSPP	Brass
6WBF6-B	3/4"	3/4"-14 BSPP	Brass
8WBF8-B	1"	1"-11 BSPP	Brass
10WBF10-B	1 1/4"	1 1/4"-11 BSPP	Brass
12WBF12-B	1 1/2"	1 1/2"-11 BSPP	Brass
6WF4-B	3/4"	1/2"-14 NPTF	Brass
6WF6-B	3/4"	3/4"-14 NPTF	Brass
8WF8-B	1"	1"-11 1/2 NPTF	Brass
8WF8	1"	1"-11 1/2 NPTF	Steel
10WF10-B	1 1/4"	1 1/4"-11 1/2 NPTF	Brass
12WF12-B	1 1/2"	1 1/2"-11 1/2 NPTF	Brass

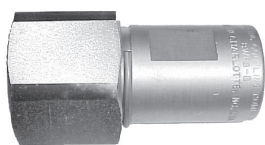

(Female Thread)

## W-SERIES THREAD-TOGETHER INTERCHANGE (HEX-NUT COUPLER)

PART NO.	BODY SIZE	THREAD SIZE	BODY MATERIAL
6WBF4-B-HN	3/4"	1/2"-14 BSPP	Brass
6WBF6-B-HN	3/4"	3/4"-14 BSPP	Brass
8WBF8-B-HN	1"	1"-11 BSPP	Brass
10WBF10-B-HN	1 1/4"	1 1/4"-11 BSPP	Brass
12WBF12-B-HN	1 1/2"	1 1/2"-11 BSPP	Brass
6WF4-B-HN	3/4"	1/2"-14 NPTF	Brass
6WF6-B-HN	3/4"	3/4"-14 NPTF	Brass
8WF8-B-HN	1"	1"-11 1/2 NPTF	Brass
10WF10-B-HN	1 1/4"	1 1/4"-11 1/2 NPTF	Brass
12WF12-B-HN	1 1/2"	1 1/2"-11 1/2 NPTF	Brass

# Quick Release Couplings



(Female Thread)

## W-SERIES THREAD-TOGETHER INTERCHANGE (NIPPLE)

PART NO.	BODY SIZE	THREAD SIZE	BODY MATERIAL
W6BF4-B	3/4"	1/2"-11 BSPP	Brass
W6BF6-B	3/4"	3/4"-14 BSPP	Brass
W8BF8-B	1"	1"-11 BSPP	Brass
W10BF10-B	1 1/4"	1 1/4"-11 BSPP	Brass
W12BF12-B	1 1/2"	1 1/2"-11 BSPP	Brass
W6F4-B	3/4"	1/2"-14 NPTF	Brass
W6F6-B	3/4"	3/4"-14 NPTF	Brass
W8F8-B	1"	1"-11 1/2 NPTF	Brass
W8F8	1"	1"-11 1/2 NPTF	Steel
W10F10-B	1 1/4"	1 1/4"-11 1/2 NPTF	Brass
W12F12-B	1 1/2"	1 1/2"-11 1/2 NPTF	Brass

H



## W-SERIES THREAD-TOGETHER INTERCHANGE (NIPPLE WITH FLANGE)

PART NO.	BODY SIZE	THREAD SIZE	BODY MATERIAL
W6F4-B-BMF	3/4"	1/2"-14 NPTF	Brass
W6BF4-B-BMF	3/4"	1/2"-14 BSPP	Brass
W6F6-B-BMF	3/4"	3/4"-14 NPTF	Brass
W6BF6-B-BMF	3/4"	3/4"-14 BSPP	Brass
W8F8-B-BMF	1"	1"-11 1/2 NPTF	Brass
W8BF8-B-BMF	1"	1"-11 BSPP	Brass
W10F10-B-BMF	1 1/4"	1 1/4"-11 1/2 NPTF	Brass
W10BF10-B-BMF	1 1/4"	1 1/4"-11 BSPP	Brass
W12F12-B-BMF	1 1/2"	1 1/2"-11 1/2 NPTF	Brass
W12BF12-B-BMF	1 1/2"	1 1/2"-11 BSPP	Brass

## HT-Series ISO16028 Flushface Interchange

### Interchange Data:

- Interchangeable to ISO16028
- Parker FEM-Series, Snap-Tite 74-Series, Hansen FF, Aeroquip/Eaton FD89, Stucchi FIRG/Series 'A',
- Faster FFN/FFI/2FFN/2FFI, Safeway FF49-Series

### Seal Components:

- $\frac{3}{8}$ ",  $\frac{1}{2}$ ", and  $\frac{3}{4}$ " nipples have molded Polyurethane valve seals, with a temperature range of -54°C to +100°C (-65°F to +212°F)
- $\frac{1}{2}$ ",  $\frac{5}{8}$ " and 1" to 2" nipples have Nitrile-Energised PTFE valve seals, with a temperature range of -40°C to +121°C (-40°F to +250°F)
- Couplers have a polyurethane valve stem O-Ring, with a temperature range of -54°C to +100°C (-65°F to +212°F)
- Ancillary coupler and nipple seals are Nitrile (Buna-N), temperature range of -40°C to +121°C (-40°F to +250°F)
- PTFE or TPC-ET Anti-Extrusion ring protects main coupling valve seal from dynamic impulse pressure damage



### Materials:

- Machined components are manufactured using solid Steel or 316 Stainless Steel bar stock
- Stainless Steel balls, retaining rings, and springs maximise corrosion resistance and extend service life
- Steel componentry is plated using ROHS Compliant Zinc Nickel for superior corrosion resistance
- Steel coupler sleeves are hardened to resist deformation and maximise service life
- Steel nipples are hardened to provide resistance to brinelling during impulse service

### Rated Pressure Chart:

HT-SERIES ISO16028 FLUSHFACE																
BODY SIZE	STEEL COUPLER/PLUG COUPLED				316 STAINLESS STEEL COUPLER/PLUG COUPLED				STEEL COUPLER UNCOUPLED				STEEL PLUG UNCOUPLED			
	Max. Working		Burst		Max. Working		Burst		Max. Working		Burst		Max. Working		Burst	
	PSI	Bar	PSI	Bar	PSI	Bar	PSI	Bar	PSI	Bar	PSI	Bar	PSI	Bar	PSI	Bar
1/4"	5000	345	20,000	1,379	-	-	-	-	5000	345	20,000	1379	5000	345	20,000	1,379
3/8"	5000	345	20,000	1,379	3500	241	17,500	1,207	5000	345	20,000	1379	5000	345	20,000	1,379
1/2"	5000	345	20,000	1,379	3400	234	17,000	1,172	5000	345	20,000	1379	5000	345	20,000	1,379
5/8"	5000	345	20,000	1,379	2920	201	14,600	1,007	5000	345	20,000	1379	5000	345	20,000	1,379
3/4"	5000	345	20,000	1,379	2920	201	14,600	1,007	5000	345	20,000	1379	5000	345	20,000	1,379
1"	5000	345	20,000	1,379	2920	201	14,600	1,007	5000	345	20,000	1379	5000	345	20,000	1,379
1 1/2"	3000	207	12,000	828	-	-	-	-	3000	207	12,000	828	3000	207	12,000	828
2"	3000	207	12,000	828	-	-	-	-	3000	207	12,000	828	3000	207	12,000	828

### Technical Specifications:

BODY SIZE	INTERCHANGE STANDARDS				FUNCTIONAL PARAMETERS				
	U.S. MILITARY	U.S. GOVERNMENT	INTERNATIONAL STANDARDS	ANSI/NFPA STANDARDS	LOCKING BALL QUANTITY	AIR INCLUSION	FLUID LOSS	VACUUM INCH HG	FLOW $\Delta P = 15$ PSI L/MIN
1/4"	-	-	ISO16028	-	12	n/a	0.010cc	N/R	11
3/8"	-	-	ISO16028	T3.20.15	12	n/a	0.010cc	N/R	41
1/2"	-	-	ISO16028	-	12	n/a	0.010cc	N/R	68
5/8"	-	-	ISO16028	-	12	n/a	0.020cc	N/R	79
3/4"	-	-	ISO16028	-	12	n/a	0.030cc	N/R	106
1"	-	-	ISO16028	-	12	n/a	0.030cc	N/R	188
1 1/2"	-	-	-	-	18	n/a	0.050cc	N/R	526
2"	-	-	-	-	20	n/a	0.070cc	N/R	846

# Quick Release Couplings

**High Flow Performance!**

High strength laser-cut valve guide maximises valve stability while minimising flow restriction.

**Compact Profile!**

Bulkhead mountable sleeve for breakaway, multi-plate, or Blindmate installations.

**Easily Reassemble Coupler & Nipple!**

DORS (dual opposing retention spheres) retention system prevents valve stem ejection during surge flow and pressure spike conditions.

Improved sealing system incorporates a high performance molded polyurethane or O-ring energised PTFE valve seal.

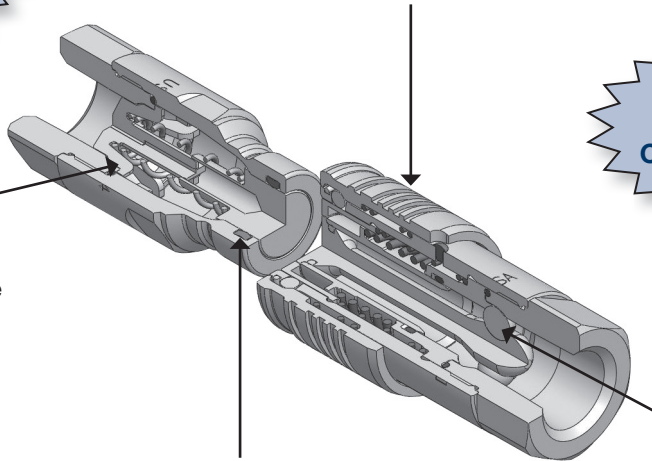

I



Note: Fits Dixon couplers only

## HT-SERIES ISO16028 FLUSHFACE INTERCHANGE (COUPLER DUST PLUG)

PART NO.	BODY SIZE	CAP LANYARD	BODY MATERIAL
2HTDP	1/4"	Nitrile	Nitrile
3HTDP	3/8"	Nitrile	Nitrile
4HTDP	1/2"	Nitrile	Nitrile
5HTDP	5/8"	Nitrile	Nitrile
6HTDP	3/4"	Nitrile	Nitrile
8HTDP	1"	Nitrile	Nitrile



Note: Fits all ISO 16028 nipples

## HT-SERIES ISO16028 FLUSHFACE INTERCHANGE (NIPPLE DUST CAP)

PART NO.	BODY SIZE	CAP LANYARD	BODY MATERIAL
HT2DC	1/4"	Nitrile	Nitrile
HT3DC	3/8"	Nitrile	Nitrile
HT4DC	1/2"	Nitrile	Nitrile
HT5DC	5/8"	Nitrile	Nitrile
HT6DC	3/4"	Nitrile	Nitrile
HT8DC	1"	Nitrile	Nitrile

## HT-SERIES ISO16028 FLUSHFACE INTERCHANGE (COUPLER)

PART NO.	BODY SIZE	THREAD SIZE	BODY MATERIAL
2HTF2	1/4"	1/4"-18NPTF	Steel
2HTBF2	1/4"	1/4"-19 BSPP	Steel
3HTF3	3/8"	3/8"-18 NPTF	Steel
3HTF3-SS	3/8"	3/8"-18 NPTF	316 Stainless Steel
3HTOF3	3/8"	9/16-18 ORB	Steel
3HTBF3	3/8"	3/8"-19 BSPP	Steel
3HTBF3-SS	3/8"	3/8"-19 BSPP	316 Stainless Steel
3HTF4	3/8"	1/2-14 NPTF	Steel
3HTF4-SS	3/8"	1/2-14 NPTF	316 Stainless Steel
3HTOF4	3/8"	3/4"-16 ORB	Steel
3HTBF4	3/8"	1/2"-14 BSPP	Steel
3HTBF4-SS	3/8"	1/2"-14 BSPP	316 Stainless Steel
4HTF4	1/2"	1/2"-14 NPTF	Steel
4HTF4-SS	1/2"	1/2"-14 NPTF	316 Stainless Steel
4HTOF4	1/2"	3/4"-16 ORB	Steel
4HTBF4	1/2"	1/2"-14 BSPP	Steel
4HTBF4-SS	1/2"	1/2"-14 BSPP	316 Stainless Steel
4HTOF5	1/2"	7/8"-14 ORB	Steel
4HTF6	1/2"	3/4"-14 NPTF	Steel
4HTF6-SS	1/2"	3/4"-14 NPTF	316 Stainless Steel
4HTOF6	1/2"	1 1/16"-12 ORB	Steel
4HTBF6	1/2"	3/4"-14 BSPP	Steel
4HTBF6-SS	1/2"	3/4"-14 BSPP	316 Stainless Steel
5HTOF5	5/8"	7/8"-14 ORB	Steel
5HTF6	5/8"	3/4"-14 NPTF	Steel
5HTF6-SS	5/8"	3/4"-14 NPTF	316 Stainless Steel
5HTOF6	5/8"	1 1/16"-12 ORB	Steel
5HTBF6	5/8"	3/4"-14 BSPP	Steel
5HTBF6-SS	5/8"	3/4"-14 BSPP	316 Stainless Steel
6HTOF5	3/4"	7/8"-14 ORB	Steel
6HTF6	3/4"	3/4"-14 NPTF	Steel
6HTF6-SS	3/4"	3/4"-14 NPTF	316 Stainless Steel
6HTOF6	3/4"	1 1/16"-12 ORB	Steel
6HTBF6	3/4"	3/4"-14 BSPP	Steel
6HTBF6-SS	3/4"	3/4"-14 BSPP	316 Stainless Steel
6HTF8	3/4"	1"-11 1/2 NPTF	Steel
6HTF8-SS	3/4"	1"-11 1/2 NPTF	316 Stainless Steel
6HTOF8	3/4"	1 5/16"-12 ORB	Steel
6HTBF8	3/4"	1"-11 BSPP	Steel
6HTBF8-SS	3/4"	1"-11 BSPP	316 Stainless Steel
8HTF8	1"	1"-11 1/2 NPTF	Steel
8HTF8-SS	1"	1"-11 1/2 NPTF	316 Stainless Steel
8HTOF8	1"	1 5/16"-12 ORB	Steel
8HTBF8	1"	1"-11 BSPP	Steel
8HTBF8-SS	1"	1"-11 BSPP	316 Stainless Steel
8HTF10	1"	1 1/4"-11 1/2 NPTF	Steel
8HTF10-SS	1"	1 1/4"-11 1/2 NPTF	316 Stainless Steel
8HTOF10	1"	1 5/8"-12 ORB	Steel
8HTBF10	1"	1 1/4"-11 BSPP	Steel
8HTBF10-SS	1"	1 1/4"-11 BSPP	316 Stainless Steel
12HTF12	1 1/2"	1 1/2"-11 1/2 NPTF	Steel
12HTBF12	1 1/2"	1 1/2"-11 BSPP	Steel
12HTOF12	1 1/2"	1 7/8"-12 ORB	Steel
16HTF16	2"	2"-11 1/2 NPTF	Steel
16HTBF16	2"	2"-11 BSPP	Steel
16HTOF16	2"	2 1/2"-12 ORB	Steel

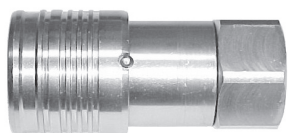

(Female Thread)



(Male Thread)

## HT SERIES ISO16028 FLUSHFACE INTERCHANGE (COUPLER)

PART NO.	BODY SIZE	THREAD SIZE	BODY MATERIAL
3HTM3	3/8"	3/8"-18 NPTF	Steel
3HTM4	3/8"	1/2"-14 NPTF	Steel
3HTOM4	3/8"	3/4"-16 ORB	Steel
4HTJB5	1/2"	7/8"-14 JIC BH	Steel
4HTRB5	1/2"	1"-14 ORFS BH	Steel
4HTJB6	1/2"	1 1/6"-12 JIC BH	Steel

### IMPORTANT

Although a special lubricant is used to protect the flushface seals during pre-service storage, the seals are still vulnerable until they are exposed to the system fluid. It is recommended to lubricate the seals before the first connection by placing a drop of oil into the main valve grooves on the face of the nipple.

# Quick Release Couplings

## HT-SERIES ISO16028 FLUSHFACE INTERCHANGE (NIPPLE)

PART NO.	BODY SIZE	THREAD SIZE	BODY MATERIAL
HT2F2	1/4"	1/4"-18 NPTF	Steel
HT2BF2	1/4"	1/4"-19 BSPP	Steel
HT3F3	3/8"	3/8"-18 NPTF	Steel
HT3F3-SS	3/8"	3/8"-18 NPTF	316 Stainless Steel
HT3OF3	3/8"	9/16"-18 ORB	Steel
HT3BF3	3/8"	3/8"-19 BSPP	Steel
HT3BF3-SS	3/8"	3/8"-19 BSPP	316 Stainless Steel
HT3F4	3/8"	1/2"-14 NPTF	Steel
HT3F4-SS	3/8"	1/2"-14 NPTF	316 Stainless Steel
HT3OF4	3/8"	3/4"-16 ORB	Steel
HT3BF4	3/8"	1/2"-14 BSPP	Steel
HT3BF4-SS	3/8"	1/2"-14 BSPP	316 Stainless Steel
HT4F4	1/2"	1/2"-14 NPTF	Steel
HT4F4-SS	1/2"	1/2"-14 NPTF	316 Stainless Steel
HT4OF4	1/2"	3/4"-16 ORB	Steel
HT4BF4	1/2"	1/2"-14 BSPP	Steel
HT4BF4-SS	1/2"	1/2"-14 BSPP	316 Stainless Steel
HT4OF5	1/2"	7/8"-14 ORB	Steel
HT4F6	1/2"	3/4"-14 NPTF	Steel
HT4F6-SS	1/2"	3/4"-14 NPTF	316 Stainless Steel
HT4OF6	1/2"	1 1/16"-12 ORB	Steel
HT4BF6	1/2"	3/4"-14 BSPP	Steel
HT4BF6-SS	1/2"	3/4"-14 BSPP	316 Stainless Steel
HT5OF5	5/8"	7/8"-14 ORB	Steel
HT5F6	5/8"	3/4"-14 NPTF	Steel
HT5F6-SS	5/8"	3/4"-14 NPTF	316 Stainless Steel
HT5OF6	5/8"	1 1/16"-12 ORB	Steel
HT5BF6	5/8"	3/4"-11 BSPP	Steel
HT5BF6-SS	5/8"	3/4"-11 BSPP	316 Stainless Steel
HT6OF5	3/4"	7/8"-14 ORB	Steel
HT6F6	3/4"	3/4"-14 NPTF	Steel
HT6F6-SS	3/4"	3/4"-14 NPTF	316 Stainless Steel
HT6OF6	3/4"	1 1/16"-12 ORB	Steel
HT6BF6	3/4"	3/4"-14 BSPP	Steel
HT6BF6-SS	3/4"	3/4"-14 BSPP	316 Stainless Steel
HT6F8	3/4"	1"-11 1/2 NPTF	Steel
HT6F8-SS	3/4"	1"-11 1/2 NPTF	316 Stainless Steel
HT6F8	3/4"	1 5/16"-12 ORB	Steel
HT6BF8	3/4"	1"-11 BSPP	Steel
HT6BF8-SS	3/4"	1"-11 BSPP	316 Stainless Steel
HT8F8	1"	1"-11 1/2 NPTF	Steel
HT8F8-SS	1"	1"-11 1/2 NPTF	316 Stainless Steel
HT8OF8	1"	1 5/16"-12 ORB	Steel
HT8BF8	1"	1"-11 BSPP	Steel
HT8BF8-SS	1"	1"-11 BSPP	316 Stainless Steel
HT8F10	1"	1 1/4"-11 1/2 NPTF	Steel
HT8F10-SS	1"	1 1/4"-11 1/2 NPTF	316 Stainless Steel
HT8OF10	1"	1 5/8"-12 ORB	Steel
HT8BF10	1"	1 1/4"-11 BSPP	Steel
HT8BF10-SS	1"	1 1/4"-11 BSPP	316 Stainless Steel
HT12F12	1 1/2"	1 1/2"-11 1/2 NPTF	Steel
HT12BF12	1 1/2"	1 1/2"-11 BSPP	Steel
HT12OF12	1 1/2"	1 7/8"-12 ORB	Steel
HT16F16	2"	2"-11 1/2 NPTF	Steel
HT16BF16	2"	2"-11 BSPP	Steel
HT16OF16	2"	2 1/2"-12 ORB	Steel

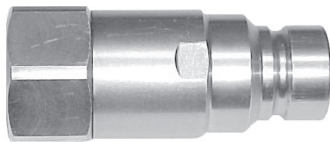

(Female Thread)



(Male Thread)

## HT-SERIES ISO16028 FLUSHFACE INTERCHANGE (NIPPLE)

PART NO.	BODY SIZE	THREAD SIZE	BODY MATERIAL
HT3M3	3/8"	3/8"-18 NPTF	Steel
HT3M4	3/8"	1/2"-14 NPTF	Steel
HT3OM4	3/8"	3/4"-16 ORB	Steel
HT4JB5	1/2"	7/8"-14 JIC BH	Steel
HT4RB5	1/2"	1"-14 ORFS BH	Steel
HT4JB6	1/2"	1 1/6"-12 JIC BH	Steel

### IMPORTANT

Although a special lubricant is used to protect the flushface seals during pre-service storage, the seals are still vulnerable until they are exposed to the system fluid. It is recommended to lubricate the seals before the first connection by placing a drop of oil into the main valve grooves on the face of the nipple.



## HTE-Series ISO 16028 Connect Under Pressure Flush Face Nipple

### Interchange Data:

- Parker FEC-Series, Stucchi APM-Series, Faster 3FFH-Series

### Materials:

- Machined components are manufactured using solid Steel bar stock.
- Steel componentry is plated using a ROHS Compliant Zinc Nickel process providing superior corrosion resistance.
- Stainless Steel retaining rings and springs maximise corrosion resistance and extend service life.
- Nipples are hardened to provide resistance to brinelling during impulse service.

### Seal Components:

- 3/8", 1/2", and 3/4" nipples have molded Polyurethane valve seals, with a temperature range of -54°C to +100°C (-65°F to +212°F).
- 5/8" and 1" nipples have Nitrile-Energised PTFE valve seals, with a temperature range of -40°C to +121°C (-40°F to +250°F).
- Ancillary nipple seals are Nitrile (Buna-N), temperature range of -40°C to +121°C (-40°F to +250°F).

### Component Terminology

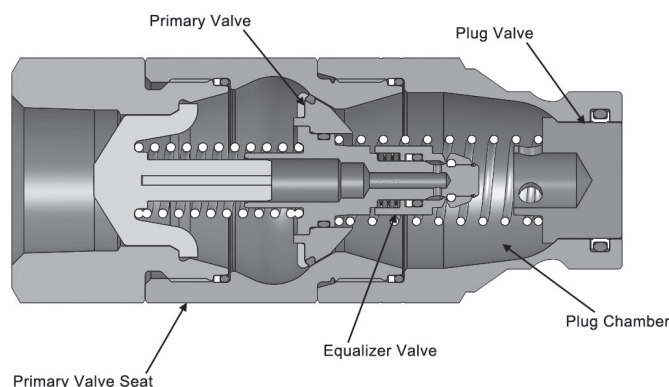

### Benefits of the new Equalizer valve system!

- Non-linear connection force at all pressures
- No maximum connection-pressure restrictions
- Head pressure or valve bleed-by has minimal effect on connection force
- Less susceptible to system contamination
- Design is scalable performing similarly in all sizes
- Smooth connection action

### Rated Pressure Chart:

HTE-SERIES ISO16028 CONNECT UNDER PRESSURE FLUSHFACE NIPPLE												
BODY SIZE	STEEL HT COUPLER/ HTE-PLUG COUPLED				HTE-PLUG UNCOUPLED				AIR INCLUSION	FLUID LOSS	VACUUM INCH HG	FLOW ΔP = 14.5 PSI L/MIN
	Maximum Working		Burst		Maximum Working		Burst					
	PSI	Bar	PSI	Bar	PSI	Bar	PSI	Bar				
3/8"	5000	345	20,000	1,380	5000	345	20,000	1,380	n/a	0.010cc	N/R	36
1/2"	5000	345	20,000	1,380	5000	345	20,000	1,380	n/a	0.010cc	N/R	56
5/8"	5000	345	20,000	1,380	5000	345	20,000	1,380	n/a	0.020cc	N/R	68
3/4"	5000	345	20,000	1,380	5000	345	20,000	1,380	n/a	0.030cc	N/R	90
1"	5000	345	20,000	1,380	5000	345	20,000	1,380	n/a	0.030cc	N/R	44

## The Equalizer Connection Process

### Stage 1: The Disconnected State

The plug has residual pressure trapped behind the primary valve, while the coupler has no trapped pressure.



### Stage 2: Plug Chamber Evacuated

The plug valve is opened, then the socket valve opens, evacuating the plug chamber to the unpressurised socket.



### Stage 3: Release Pressure

The connection continues, with the Equalizer valve being activated, releasing the trapped pressure into the plug chamber, then to the unpressurised socket.



### Stage 4: Complete the connection

The primary valve can now open easily, since there is no longer any pressure trapped behind it, allowing the socket to fully engage the plug.

J



**HTE-SERIES ISO 16028 CONNECT UNDER PRESSURE  
FLUSH FACE NIPPLE (FEMALE THREADS)**

PART NO	BODY SIZE	THREADS	MATERIAL
HTE3F4	3/8"	1/2"-14 NPTF	Steel
HTE3BF4	3/8"	1/2"-14 BSPP	Steel
HTE3OF4	3/8"	3/4"-16 ORB	Steel
HTE4F4	1/2"	1/2"-14 NPTF	Steel
HTE4BF4	1/2"	1/2"-14 BSPP	Steel
HTE4OF4	1/2"	3/4"-16 ORB	Steel
HTE4OF5	1/2"	7/8"-14 ORB	Steel
HTE4F6	1/2"	3/4"-14 NPTF	Steel
HTE4BF6	1/2"	3/4"-14 BSPP	Steel
HTE4OF6	1/2"	1 1/16"-12 ORB	Steel
HTE5OF5	5/8"	7/8"-14 ORB	Steel
HTE5F6	5/8"	3/4"-14 NPTF	Steel
HTE5BF6	5/8"	3/4"-14 BSPP	Steel
HTE5OF6	5/8"	1 1/16"-12 ORB	Steel
HTE6F6	3/4"	3/4"-14 NPTF	Steel
HTE6BF6	3/4"	3/4"-14 BSPP	Steel
HTE6OF6	3/4"	1 1/16"-12 ORB	Steel
HTE6F8	3/4"	1"-11 1/2 NPTF	Steel
HTE6BF8	3/4"	1"-11 BSPP	Steel
HTE6OF8	3/4"	1-5/16"-12 ORB	Steel
HTE8F8	1"	1"-11 1/2 NPTF	Steel
HTE8BF8	1"	1"-11 BSPP	Steel
HTE8OF8	1"	1 5/16"-12 ORB	Steel
HTE8F10	1"	1 1/4"-11 1/2 NPTF	Steel
HTE8BF10	1"	1 1/4"-11 BSPP	Steel
HTE8OF10	1"	1 5/8"-12 ORB	Steel

For use with HT-Series Couplers

## ST-Series Hydraulic Coupling

### Interchange Data:

- Interchangeable with Snap-Tite 71-Series

### Materials:

- Machined components are manufactured using solid Steel or 316 stainless bar stock.
- Stainless Steel balls, retaining rings, and springs maximise corrosion resistance and extend service life.
- Steel componentry is plated using ROHS Compliant Trivalent Chrome.
- Steel coupler sleeves are hardened to resist deformation and maximise service life.
- Steel nipples are hardened to provide heavy duty performance.



### Seal Components:

- Nitrile (Buna-N) seals are standard, providing a temperature range of -40°C to +121°C (-40°F to +250°F).
- All couplers and nipples incorporate PTFE or TPC-ET anti-extrusion rings to protect the seal components from dynamic impulse damage.

### Rated Pressure Chart:

ST-SERIES SNAP-TITE 71-SERIES INTERCHANGE								
BODY SIZE	STEEL COUPLER/PLUG COUPLED				316 STAINLESS COUPLER/PLUG COUPLED			
	Max. Working		Burst		Max. Working		Burst	
	PSI	Bar	PSI	Bar	PSI	Bar	PSI	Bar
1/4"	10,000	700	27,300	1,800	5,000	345	28,000	1,900
3/8"	10,000	700	27,300	1,800	5,000	345	28,000	1,900
1/2"	10,000	700	22,500	1,500	5,000	345	25,000	1,700
3/4"	7,500	500	20,200	1,400	5,000	345	22,800	1,550
1"	7,500	500	19,400	1,300	4,000	275	18,500	1,250
1"-V2	8,500	585	25,900	1,750	-	-	-	-
2"	5,000	345	16,000	1,100	3,000	200	10,000	700

### Technical Specifications:

BODY SIZE	INTERCHANGE STANDARDS				FUNCTIONAL PARAMETERS				
	U.S. MILITARY	U.S. GOVERNMENT	INTERNATIONAL STANDARDS	ANSI/NFPA STANDARDS	LOCKING BALL QUANTITY	AIR INCLUSION	FLUID LOSS	VACUUM INCH HG	FLOW $\Delta P = 22$ PSI L/MIN
1/4"	-	-	-	-	10	0.01cc	0.02cc	N/R	11
3/8"	-	-	-	-	10	0.02cc	0.02cc	N/R	28
1/2"	-	-	-	-	12	0.03cc	0.03cc	N/R	56
3/4"	-	-	-	-	12	0.04cc	0.06cc	N/R	113
1"	-	-	-	-	12	0.06cc	0.07cc	N/R	169
1"-V2	-	-	-	-	12	0.09cc	0.10cc	N/R	188
2"	-	-	-	-	15	3.14cc	5.25cc	N/R	564

Note: Minimum burst pressure ratings were established under laboratory conditions using a Static Burst Unit (SBU).

For high impulse applications and to meet Det Norske Veritas (DNV) compliance, the burst pressure must be divided by four (4) to ensure a 4:1 safety factor during system operation.

# Quick Release Couplings



## ST-SERIES COUPLER DUST PLUG

PART NO	BODY SIZE	LANYARD	BODY MATERIAL
2STDPA	1/4"	SS Bead Chain	Aluminium
3STDPA	3/8"	SS Bead Chain	Aluminium
4STDPA	1/2"	SS Bead Chain	Aluminium
6STDPA	3/4"	SS Bead Chain	Aluminium
8STDPA	1"	SS Bead Chain	Aluminium
8STDPA-V2	1 1/2"	SS Bead Chain	Aluminium
16STDPA	2"	SS Bead Chain	Aluminium



## ST-SERIES NIPPLE DUST PLUG

PART NO	BODY SIZE	LANYARD	BODY MATERIAL
ST2DC-A	1/4"	SS Bead Chain	Aluminium
ST3DC-A	3/8"	SS Bead Chain	Aluminium
ST4DC-A	1/2"	SS Bead Chain	Aluminium
ST6DC-A	3/4"	SS Bead Chain	Aluminium
ST8DC-A	1"	SS Bead Chain	Aluminium
ST8DC-A-V2	1 1/2"	SS Bead Chain	Aluminium
ST16DC-A	2"	SS Bead Chain	Aluminium

K

## ST-SERIES SNAP-TITE '71' INTERCHANGE (AUTOMATIC COUPLER)

PART NO.	BODY SIZE	THREAD SIZE	BODY MATERIAL
2STF2	1/4"	1/4" - 18 NPTF	Steel
2STF2-SS	1/4"	1/4" - 18 NPTF	316 Stainless Steel
2STBF2	1/4"	1/4" - 19 BSPP	Steel
2STBF2-SS	1/4"	1/4" - 19 BSPP	316 Stainless Steel
3STF2	3/8"	1/4" - 18 NPTF	Steel
3STF3	3/8"	3/8" - 18 NPTF	Steel
3STF3-SS	3/8"	3/8" - 18 NPTF	316 Stainless Steel
3STBF3	3/8"	3/8" - 19 BSPP	Steel
3STBF3-SS	3/8"	3/8" - 19 BSPP	316 Stainless Steel
3STF4	3/8"	1/2" - 14 NPTF	Steel
3STF4-SS	3/8"	1/2" - 14 NPTF	316 Stainless Steel
3STBF4	3/8"	1/2" - 14 BSPP	Steel
3STBF4-SS	3/8"	1/2" - 14 BSPP	316 Stainless Steel
4STF4	1/2"	1/2" - 14 NPTF	Steel
4STF4-SS	1/2"	1/2" - 14 NPTF	316 Stainless Steel
4STBF4	1/2"	1/2" - 14 BSPP	Steel
4STBF4-SS	1/2"	1/2" - 14 BSPP	316 Stainless Steel
4STOF4	1/2"	3/4" - 16 ORB	Steel
6STF6	3/4"	3/4" - 14 NPTF	Steel
6STF6-SS	3/4"	3/4" - 14 NPTF	316 Stainless Steel
6STOF6	3/4"	1 1/16" - 12 ORB	Steel
6STOF6-SS	3/4"	1 1/16" - 12 ORB	316 Stainless Steel
6STBF6	3/4"	3/4" - 14 BSPP	Steel
6STBF6-SS	3/4"	3/4" - 14 BSPP	316 Stainless Steel
8STF8	1"	1" - 11 1/2 NPTF	Steel
8STF8-SS	1"	1" - 11 1/2 NPTF	316 Stainless Steel
8STOF8	1"	15/16" - 12 ORB	Steel
8STOF8-SS	1"	15/16" - 12 ORB	316 Stainless Steel
8STBF8	1"	1" - 11 BSPP	Steel
8STBF8-SS	1"	1" - 11 BSPP	316 Stainless Steel
8STF10	1"	1 1/4" - 11 1/2 NPTF	Steel
8STF10-SS	1"	1 1/4" - 11 1/2 NPTF	316 Stainless Steel
8STOF10	1"	15/8" - 12 ORB	Steel
8STOF10-SS	1"	15/8" - 12 ORB	316 Stainless Steel
8STBF10	1"	1 1/4" - 11 BSPP	Steel
8STBF10-SS	1"	1 1/4" - 11 BSPP	316 Stainless Steel

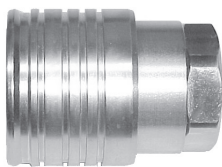

(Female Thread)

## ST-SERIES SNAP-TITE '71' INTERCHANGE (NIPPLE)

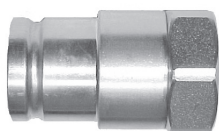

(Female Thread)

PART NO.	BODY SIZE	THREAD SIZE	BODY MATERIAL
ST2F2	1/4"	1/4"-18 NPTF	Steel
ST2F2-SS	1/4"	1/4"-18 NPTF	316 Stainless Steel
ST2BF2	1/4"	1/4"-19 BSPP	Steel
ST2BF2-SS	1/4"	1/4"-19 BSPP	316 Stainless Steel
ST3F2	3/8"	1/4"-18 NPTF	Steel
ST3F3	3/8"	3/8"-18 NPTF	Steel
ST3F3-SS	3/8"	3/8"-18 NPTF	316 Stainless Steel
ST3BF3	3/8"	3/8"-19 BSPP	Steel
ST3BF3-SS	3/8"	3/8"-19 BSPP	316 Stainless Steel
ST3F4	3/8"	1/2"-14 NPTF	Steel
ST3F4-SS	3/8"	1/2"-14 NPTF	316 Stainless Steel
ST3BF4	3/8"	1/2"-14 BSPP	Steel
ST3BF4-SS	3/8"	1/2"-14 BSPP	316 Stainless Steel
ST4F4	1/2"	1/2"-14 NPTF	Steel
ST4F4-SS	1/2"	1/2"-14 NPTF	316 Stainless Steel
ST4BF4	1/2"	1/2"-14 BSPP	Steel
ST4BF4-SS	1/2"	1/2"-14 BSPP	316 Stainless Steel
ST4OF4	1/2"	3/4"-16 ORB	Steel
ST6F6	3/4"	3/4"-14 NPTF	Steel
ST6F6-SS	3/4"	3/4"-14 NPTF	316 Stainless Steel
ST60F6	3/4"	1 1/16"-12 ORB	Steel
ST60F6-SS	3/4"	1 1/16"-12 ORB	316 Stainless Steel
ST6BF6	3/4"	3/4"-14 BSPP	Steel
ST6BF6-SS	3/4"	3/4"-14 BSPP	316 Stainless Steel
ST8F8	1"	1"-11 1/2 NPTF	Steel
ST8F8-SS	1"	1"-11 1/2 NPTF	316 Stainless Steel
ST80F8	1"	1 5/16"-12 ORB	Steel
ST80F8-SS	1"	1 5/16"-12 ORB	316 Stainless Steel
ST8BF8	1"	1"-11 BSPP	Steel
ST8BF8-SS	1"	1"-11 BSPP	316 Stainless Steel
ST8F10	1"	1 1/4"-11 1/2 NPTF	Steel
ST8F10-SS	1"	1 1/4"-11 1/2 NPTF	316 Stainless Steel
ST80F10	1"	1 5/8"-12 ORB	Steel
ST80F10-SS	1"	1 5/8"-12 ORB	316 Stainless Steel
ST8BF10	1"	1 1/4"-11 BSPP	Steel
ST8BF10-SS	1"	1 1/4"-11 BSPP	316 Stainless Steel



(Female Thread)

## ST-SERIES SNAP-TITE 71-SERIES 'OLD STYLE' INTERCHANGE COUPLER

PART NO	BODY SIZE	THREAD SIZE	BODY MATERIAL
8STF8-V2	1"	1" - 11 <sup>1</sup> / <sub>2</sub> NPTF	Steel
8STBF8-V2	1"	1" - 11 BSPP	Steel
8STF10-V2	1"	1 <sup>1</sup> / <sub>4</sub> " - 11 1/2 NPTF	Steel
16STF12	2"	1 <sup>1</sup> / <sub>2</sub> " - 11 1/2 NPTF	Steel
16STBF12	2"	1 <sup>1</sup> / <sub>2</sub> " - 11 BSPP	Steel
16STOF12	2"	1 <sup>7</sup> / <sub>8</sub> " - 12 ORB	Steel
16STF16	2"	2" - 11 <sup>1</sup> / <sub>2</sub> NPTF	Steel
16STF16-SS	2"	2" - 11 <sup>1</sup> / <sub>2</sub> NPTF	316 Stainless Steel
16STBF16	2"	2" - 11 BSPP	Steel
16STOF16	2"	2 <sup>1</sup> / <sub>2</sub> " - 12 ORB	Steel

K

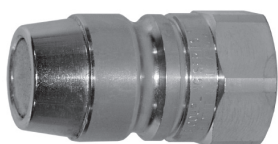

(Female Thread)

## ST-SERIES SNAP-TITE 71-SERIES 'OLD STYLE' INTERCHANGE NIPPLE

PART NO	BODY SIZE	THREAD SIZE	BODY MATERIAL
ST8F8-V2	1"	1" - 11 <sup>1</sup> / <sub>2</sub> NPTF	Steel
ST8BF8-V2	1"	1" - 11 BSPP	Steel
ST8F10-V2	1"	1 <sup>1</sup> / <sub>4</sub> " - 11 <sup>1</sup> / <sub>2</sub> NPTF	Steel
ST16F12	2"	1 <sup>1</sup> / <sub>2</sub> " - 11 <sup>1</sup> / <sub>2</sub> NPTF	Steel
ST16BF12	2"	1 <sup>1</sup> / <sub>2</sub> " - 11 BSPP	Steel
ST16OF12	2"	1 <sup>7</sup> / <sub>8</sub> " - 12 ORB	Steel
ST16F16	2"	2" - 11 <sup>1</sup> / <sub>2</sub> NPTF	Steel
ST16F16-SS	2"	2" - 11 <sup>1</sup> / <sub>2</sub> NPTF	316 Stainless Steel
ST16BF16	2"	2" - 11 BSPP	Steel
ST16OF16	2"	2 <sup>1</sup> / <sub>2</sub> " - 12 ORB	Steel

## WS-Series High Pressure Wing Style

### Interchange Data:

- Snap-Tite 75-Series, Hydraulics Inc. Series-5TV, DNP VFF-HD, Stucchi VOF, Faster OGV, Eaton FD85, Holmbury LC

### Materials:

- Machined components are manufactured using solid Steel or 316 Stainless Steel bar stock.
- Stainless Steel retaining rings, and springs maximise corrosion resistance and extend service life.
- Steel componentry is plated using ROHS Compliant Zinc Nickel for superior corrosion resistance.
- Rugged high-strength Steel sand-cast wing nut for threaded connect and disconnect operation.
- 316 Stainless Steel nipple connection-threads are coated to prevent galling during connection/disconnection.

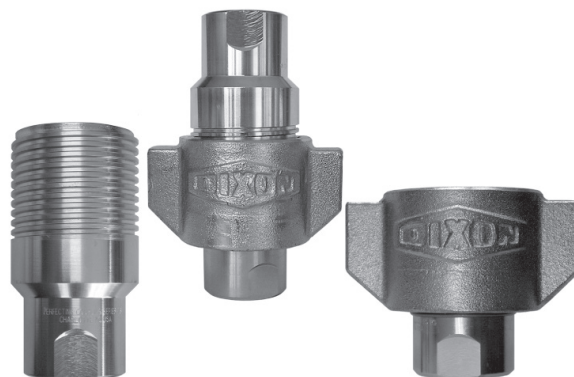

### Seal Components:

- Nitrile (Buna-N) seals are standard, providing a temperature range of -40°C to +121°C (-40°F to +250°F)
- PTFE anti-extrusion ring protects main coupling O-Ring from dynamic impulse pressure damage.
- Main valve seal is 'housed' to improve seal integrity during pressurised connection/disconnection.

### Rated Pressure Chart:

WS-SERIES HIGH PRESSURE WINGSTYLE INTERCHANGE (CONNECTED)								
BODY SIZE	STEEL COUPLER/PLUG				316 STAINLESS STEEL COUPLER/PLUG			
	Max. Working		Burst		Max. Working		Burst	
	PSI	Bar	PSI	Bar	PSI	Bar	PSI	Bar
3/4"	5,000	345	32,800	2,200	3,000	200	20,000	1,400
1"	5,000	345	25,100	1,700	3,000	200	20,000	1,400
1 1/4"	5,000	345	25,100	1,700	3,000	200	15,000	1,000
1 1/2"	5,000	345	20,000	1,400	3,000	200	15,000	1,000
2"	5,000	345	15,000	1,000	3,000	200	15,000	1,000

### Technical Specifications:

BODY SIZE	INTERCHANGE STANDARDS				FUNCTIONAL PARAMETERS				
	U.S. MILITARY	U.S. GOVERNMENT	INTERNATIONAL STANDARDS	ANSI/NFPA STANDARDS	LOCKING BALL QUANTITY	AIR INCLUSION	FLUID LOSS	VACUUM INCH HG	FLOW ΔP = 30 PSI L/MIN
3/4"	-	-	-	-	Threaded	10cc	10cc	27.4	132
1"	-	-	-	-	Threaded	23cc	15cc	27.4	244
1 1/4"	-	-	-	-	Threaded	50cc	30cc	27.4	395
1 1/2"	-	-	-	-	Threaded	100cc	60cc	27.4	602
2"	-	-	-	-	Threaded	200cc	135cc	27.4	1015

# Quick Release Couplings



## WS-SERIES COUPLER RIGID DUST PLUG

PART NO	BODY SIZE	LANYARD	BODY MATERIAL
6WSDP-A	3/4"	SS Bead Chain	Aluminium
8WSDP-A	1"	SS Bead Chain	Aluminium
10WSDP-A	1 1/4"	SS Bead Chain	Aluminium
12WSDP-A	1 1/2"	SS Bead Chain	Aluminium
16WSDP-A	2"	SS Bead Chain	Aluminium

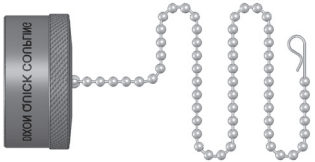

## WS-SERIES NIPPLE RIGID DUST CAP

PART NO	BODY SIZE	LANYARD	BODY MATERIAL
WS6DC-A	3/4"	SS Bead Chain	Aluminium
WS8DC-A	1"	SS Bead Chain	Aluminium
WS10DC-A	1 1/4"	SS Bead Chain	Aluminium
WS12DC-A	1 1/2"	SS Bead Chain	Aluminium
WS16DC-A	2"	SS Bead Chain	Aluminium

L

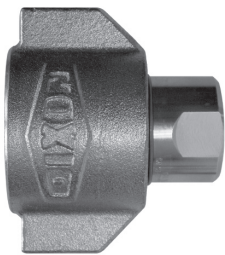

(Female Thread)

Wrench flats are pictured, non-flat fittings are standard

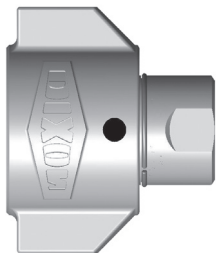

WS coupler with view port example

## WS-SERIES HIGH PRESSURE WINGSTYLE INTERCHANGE COUPLER

PART NO	BODY SIZE	THREAD SIZE	BODY MATERIAL
6WSF4	3/4"	1/2" - 14 NPTF	Steel
6WSF6	3/4"	3/4" - 14 NPTF	Steel
6WSF6-SS	3/4"	3/4" - 14 NPTF	316 Stainless Steel
6WSBF6	3/4"	3/4" - 14 BSPP	Steel
6WSBF6-SS	3/4"	3/4" - 14 BSPP	316 Stainless Steel
6WSOF6	3/4"	1 1/16" - 12 ORB	Steel
8WSF8	1"	1" - 11 1/2 NPTF	Steel
8WSF8-SS	1"	1" - 11 1/2 NPTF	316 Stainless Steel
8WSBF8	1"	1" - 11 BSPP	Steel
8WSBF8-SS	1"	1" - 11 BSPP	316 Stainless Steel
8WSOF8	1"	1 5/16" - 12 ORB	Steel
10WSF10	1 1/4"	1 1/4" - 11 1/2 NPTF	Steel
10WSF10-SS	1 1/4"	1 1/4" - 11 1/2 NPTF	316 Stainless Steel
10WSBF10	1 1/4"	1 1/4" - 11 BSPP	Steel
10WSBF10-SS	1 1/4"	1 1/4" - 11 BSPP	316 Stainless Steel
10WSOF10	1 1/4"	1 5/8" - 12 ORB	Steel
12WSF12	1 1/2"	1 1/2" - 11 1/2 NPTF	Steel
12WSF12-SS	1 1/2"	1 1/2" - 11 1/2 NPTF	316 Stainless Steel
12WSBF12	1 1/2"	1 1/2" - 11 BSPP	Steel
12WSBF12-SS	1 1/2"	1 1/2" - 11 BSPP	316 Stainless Steel
12WSOF12	1 1/2"	1 7/8" - 12 ORB	Steel
16WSF16	2"	2" - 11 1/2 NPTF	Steel
16WSF16-SS	2"	2" - 11 1/2 NPTF	316 Stainless Steel
16WSBF16	2"	2" - 11 BSPP	Steel
16WSBF16-SS	2"	2" - 11 BSPP	316 Stainless Steel
16WSOF16	2"	2" - 12 ORB	Steel

\* Wrench flats may result in reduced pressure performance.



## WS-SERIES HIGH PRESSURE WINGSTYLE INTERCHANGE NIPPLE

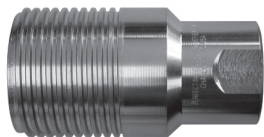

(Female Thread)

Wrench flats are pictured,  
non-flat fittings are standard

PART NO	BODY SIZE	THREAD SIZE	BODY MATERIAL
WS6F4	3/4"	1/2" - 14 NPTF	Steel
WS6F6	3/4"	3/4" - 14 NPTF	Steel
WS6F6-SS	3/4"	3/4" - 14 NPTF	316 Stainless Steel
WS6BF6	3/4"	3/4" - 14 BSPP	Steel
WS6BF6-SS	3/4"	3/4" - 14 BSPP	316 Stainless Steel
WS6OF6	3/4"	1 <sup>1</sup> / <sub>16</sub> " - 12 ORB	Steel
WS8F8	1"	1" - 11 <sup>1</sup> / <sub>2</sub> NPTF	Steel
WS8F8-SS	1"	1" - 11 <sup>1</sup> / <sub>2</sub> NPTF	316 Stainless Steel
WS8BF8	1"	1" - 11 BSPP	Steel
WS8BF8-SS	1"	1" - 11 BSPP	316 Stainless Steel
WS8OF8	1"	1 <sup>5</sup> / <sub>16</sub> " - 12 ORB	Steel
WS10F10	1 <sup>1</sup> / <sub>4</sub> "	1 <sup>1</sup> / <sub>4</sub> " - 11 <sup>1</sup> / <sub>2</sub> NPTF	Steel
WS10F10-SS	1 <sup>1</sup> / <sub>4</sub> "	1 <sup>1</sup> / <sub>4</sub> " - 11 <sup>1</sup> / <sub>2</sub> NPTF	316 Stainless Steel
WS10BF10	1 <sup>1</sup> / <sub>4</sub> "	1 <sup>1</sup> / <sub>4</sub> " - 11 BSPP	Steel
WS10BF10-SS	1 <sup>1</sup> / <sub>4</sub> "	1 <sup>1</sup> / <sub>4</sub> " - 11 BSPP	316 Stainless Steel
WS10OF10	1 <sup>1</sup> / <sub>4</sub> "	1 <sup>5</sup> / <sub>8</sub> " - 12 ORB	Steel
WS12F12	1 <sup>1</sup> / <sub>2</sub> "	1 <sup>1</sup> / <sub>2</sub> " - 11 <sup>1</sup> / <sub>2</sub> NPTF	Steel
WS12F12-SS	1 <sup>1</sup> / <sub>2</sub> "	1 <sup>1</sup> / <sub>2</sub> " - 11 <sup>1</sup> / <sub>2</sub> NPTF	316 Stainless Steel
WS12BF12	1 <sup>1</sup> / <sub>2</sub> "	1 <sup>1</sup> / <sub>2</sub> " - 11 BSPP	Steel
WS12BF12-SS	1 <sup>1</sup> / <sub>2</sub> "	1 <sup>1</sup> / <sub>2</sub> " - 11 BSPP	316 Stainless Steel
WS12OF12	1 <sup>1</sup> / <sub>2</sub> "	1 <sup>7</sup> / <sub>8</sub> " - 12 ORB	Steel
WS16F16	2"	2" - 11 <sup>1</sup> / <sub>2</sub> NPTF	Steel
WS16F16-SS	2"	2" - 11 <sup>1</sup> / <sub>2</sub> NPTF	316 Stainless Steel
WS16BF16	2"	2" - 11 BSPP	Steel
WS16BF16-SS	2"	2" - 11 BSPP	316 Stainless Steel
WS16OF16	2"	2" - 12 ORB	Steel

## Dixon Blowout Prevention Couplings

### Application:

- designed specifically for blow-out prevention systems on drilling rigs

### Product Offering:

- VEP-BOP Series:
  - thread to connect flush face interchange
  - $\frac{3}{8}$ " to  $1\frac{1}{2}$ " in Steel
- H-BOP Series:
  - ISO-B interchange
  - $\frac{1}{2}$ " to 1" in Steel and 316 stainless
- WS-BOP Series:
  - same reliable Wing coupling you know, new red components
  - $\frac{3}{4}$ " to 2" in Steel and 316 stainless

### Features:

- fire tested and Lloyd's certified to 700°C (1300°F) in accordance with API 16D, certificate available upon request
- certified at a test pressure of 5,000 PSI
- red powder coated components and external seals provide easy BOP approved identification
- critical seals are FKM



M



## VEP-BOP Series Hydraulic Couplings

### Interchange Data:

- Stucchi VEP/VEP-HD Series, DNP FSI-BOP Series

### Seal Components:

- Blow-out Prevention (BOP) coupling critical seals are severe service FKM
- PTFE Anti-Extrusion ring protects main coupling valve seal from dynamic impulse pressure damage

### Materials:

- Machined components are manufactured using solid Steel bar stock
- Stainless Steel retaining rings and springs maximise corrosion resistance and extend service life
- Steel components are plated using ROHS Compliant Zinc Nickel
- Red powder coated components and external O-rings for easy BOP service identification

- BOP couplings have been fire tested and Lloyd's certified to 700°C (1300°F) in accordance with API 16D. Certificate available upon request

- Use VEP dust caps and dust plugs found on page 22

LLOYD'S TEST PRESSURE	
BODY SIZE	PSI
3/8"	5,000
1/2"	5,000
3/4"	5,000
1"	5,000
1 1/4"	5,000
1 1/2"	5,000

M

### Rated Pressure Chart:

VEP-BOP SERIES INTERCHANGE																
BODY SIZE	PRESSURE RATING				BURST PRESSURE						MAX. PRESSURE CONNECT		MAX. PRESSURE DISCONNECT		RATED FLOW ΔP=21.75 PSI	
	ISO WORKING		MAX. IMPULSE		CONNECTED		COUPLER		PLUG							
	PSI	MPA	PSI	MPA	PSI	MPA	PSI	MPA	PSI	MPA	PSI	MPA	PSI	MPA	L/MIN	
3/8"	5,500	38	8,000	55	22,000	152	18,000	124	20,000	138	4,500	31	4,500	31	40	
1/2"	5,500	38	8,000	55	22,000	152	18,000	124	20,000	138	4,500	31	4,500	31	66	
3/4"	5,500	38	8,000	55	22,000	152	18,000	124	20,000	138	4,500	31	4,500	31	85	
1"	5,500	38	7,500	52	22,000	152	14,500	100	20,000	138	3,625	25	3,625	25	123	
1 1/4"	5,000	35	7,000	48	20,000	138	14,500	100	16,000	110	3,625	25	3,625	25	174	
1 1/2"	5,000	31	5,800	40	18,000	124	12,000	83	14,500	100	3,000	21	3,000	21	360	

Contact Dixon for availability of other end configurations.

# Quick Release Couplings

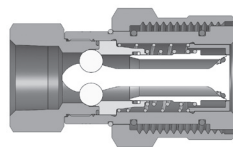
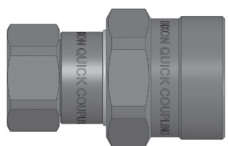

(Female Thread)

## VEP-BOP SERIES BLOWOUT PREVENTION SAFETY COUPLER

PART NO	BODY SIZE	THREADS SIZE	BODY MATERIAL
3VEP3-BOP	3/8"	3/8" - 18 NPTF	Steel
4VEPF4-BOP	1/2"	1/2" - 14 NPTF	Steel
6VEPF6-BOP	3/4"	3/4" - 14 NPTF	Steel
8VEPF8-BOP	1"	1" - 11 1/2 NPTF	Steel
10VEPF10-BOP	1 1/4"	1 1/4" - 11 1/2 NPTF	Steel
12VEPF12-BOP	1 1/2"	1 1/2" - 11 1/2 NPTF	Steel

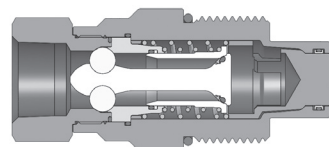

(Female Thread)

## VEP-BOP SERIES BLOWOUT PREVENTION SAFETY NIPPLE

PART NO	BODY SIZE	THREADS SIZE	BODY MATERIAL
VEP3F3-BOP	3/8"	3/8" - 18 NPTF	Steel
VEP4F4-BOP	1/2"	1/2" - 14 NPTF	Steel
VEP6F6-BOP	3/4"	3/4" - 14 NPTF	Steel
VEP8F8-BOP	1"	1" - 11 1/2 NPTF	Steel
VEP10F10-BOP	1 1/4"	1 1/4" - 11 1/2 NPTF	Steel
VEP12F12-BOP	1 1/2"	1 1/2" - 11 1/2 NPTF	Steel

M

## WS-BOP Series Hydraulic Couplings

### Interchange Data:

- Snap-Tite 75-Series, DNP VFF-HD BOP Series

### Seal Components:

- Blow-out Prevention (BOP) couplings contain severe service FKM seals
- PTFE Anti-Extrusion ring protects main coupling valve seal from dynamic impulse pressure damage
- Main valve seal is “housed” to improve seal integrity during pressurised connection/disconnection

### Materials:

- Machined components are manufactured using solid Steel or 316 Stainless Steel bar stock
- Stainless Steel retaining rings, and springs maximise corrosion resistance and extend service life
- Steel componentry is plated using ROHS Compliant Zinc Nickel
- Rugged high-strength Steel wing nut for threaded connect and disconnect operation
- 316 Stainless Steel nipple connection-threads are coated to prevent galling during connection/disconnection
- Red powder coated coupler wing-nut and external nipple O-ring for easy BOP service identification

- **BOP couplings have been fire tested and Lloyd’s certified to 700°C (1300°F) in accordance with API 16D. Certificate available upon request**

- Use WS dust caps and dust plugs found on page 40

M

### Rated Pressure Chart:

WS-BOP SERIES HIGH PRESSURE WINGSTYLE INTERCHANGE (CONNECTED)								
BODY SIZE	STEEL COUPLER/PLUG				316 STAINLESS STEEL COUPLER/PLUG			
	Max. Working		Burst		Max. Working		Burst	
	PSI	Bar	PSI	Bar	PSI	Bar	PSI	Bar
3/4"	5,000	345	32,800	2,200	5,000	345	20,000	1,400
1"	5,000	345	25,100	1,700	5,000	345	20,000	1,400
1 1/4"	5,000	345	25,100	1,700	5,000	345	15,000	1,000
1 1/2"	5,000	345	20,000	1,400	5,000	345	15,000	1,000
2"	5,000	345	15,000	1,000	5,000	345	15,000	1,000

### Technical Specifications:

BODY SIZE	FUNCTIONAL PARAMETERS					LLOYD’S TEST PRESSURE
	LOCKING MECHANISM	AIR INCLUSION	FLUID LOSS	VACUUM INCH HG	FLOW ΔP = 30 PSI L/MIN	PSI
3/4"	Threaded	10cc	10cc	27.4	132	5,000
1"	Threaded	23cc	15cc	27.4	244	5,000
1 1/4"	Threaded	50cc	30cc	27.4	395	5,000
1 1/2"	Threaded	100cc	60cc	27.4	602	5,000
2"	Threaded	200cc	135cc	27.4	1015	5,000



# Quick Release Couplings

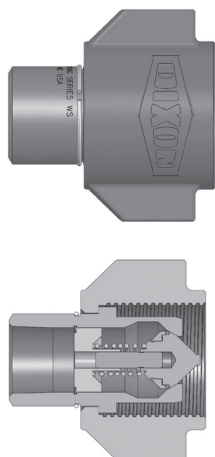

(Female Thread)

## WS-BOP SERIES BLOWOUT PREVENTION SAFETY COUPLER

PART NO	BODY SIZE	THREADS SIZE	BODY MATERIAL
6WSF4-BOP	3/4"	1/2" - 14 NPTF	Steel
6WSF6-BOP	3/4"	3/4" - 14 NPTF	Steel
6WSF6-SS-BOP	3/4"	3/4" - 14 NPTF	316 Stainless Steel
8WSF8-BOP	1"	1" - 11 1/2 NPTF	Steel
8WSF8-SS-BOP	1"	1" - 11 1/2 NPTF	316 Stainless Steel
10WSF10-BOP	1 1/4"	1 1/4" - 11 1/2 NPTF	Steel
10WSF10-SS-BOP	1 1/4"	1 1/4" - 11 1/2 NPTF	316 Stainless Steel
12WSF12-BOP	1 1/2"	1 1/2" - 11 1/2 NPTF	Steel
12WSF12-SS-BOP	1 1/2"	1 7/8" - 11 1/2 NPTF	316 Stainless Steel
16WSF16-BOP	2"	2" - 11 1/2 NPTF	Steel
16WSF16-SS-BOP	2"	2" - 11 1/2 NPTF	316 Stainless Steel

## WS-BOP SERIES BLOWOUT PREVENTION SAFETY NIPPLE

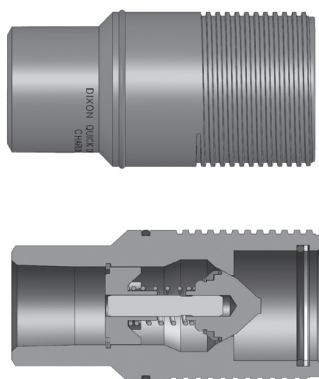

(Female Thread)

PART NO	BODY SIZE	THREADS SIZE	BODY MATERIAL
WS6F4-BOP	3/4"	1/2" - 14 NPTF	Steel
WS6F6-BOP	3/4"	3/4" - 14 NPTF	Steel
WS6F6-SS-BOP	3/4"	3/4" - 14 NPTF	316 Stainless Steel
WS8F8-BOP	1"	1" - 11 1/2 NPTF	Steel
WS8F8-SS-BOP	1"	1" - 11 1/2 NPTF	316 Stainless Steel
WS10F10-BOP	1 1/4"	1 1/4" - 11 1/2 NPTF	Steel
WS10F10-SS-BOP	1 1/4"	1 1/4" - 11 1/2 NPTF	316 Stainless Steel
WS12F12-BOP	1 1/2"	1 1/2" - 11 1/2 NPTF	Steel
WS12F12-SS-BOP	1 1/2"	1 7/8" - 11 1/2 NPTF	316 Stainless Steel
WS16F16-BOP	2"	2" - 11 1/2 NPTF	Steel
WS16F16-SS-BOP	2"	2" - 11 1/2 NPTF	316 Stainless Steel

M

## H-BOP Series Hydraulic Couplings

### Interchange Data:

- Eaton/Hansen HKFR-Series, DNP HNV-BOP Series
- Interchangeable to ISO7241 Series B

### Seal Components:

- Blow-out Prevention (BOP) couplings contain severe service FKM seals
- PTFE Anti-Extrusion ring protects main coupling body seal from dynamic impulse pressure damage
- Coupler has redundant O-ring sealing system
- Valve seals are crimped in place to maintain integrity during excessive flow conditions and pressurised connection

### Materials:

- Machined components are manufactured using solid Steel or 316 Stainless Steel bar stock.
- Stainless Steel balls, retaining rings, and springs maximise corrosion resistance and extend service life.
- Steel componentry is plated using ROHS Compliant Trivalent Chrome.
- Steel coupler sleeves are hardened to resist deformation and maximise service life.
- Steel nipples are hardened to provide heavy duty performance and resist brinelling.
- Red powder coated coupler sleeve and nipple hex for easy BOP service identification
- Locking sleeve is standard

- **BOP couplings have been fire tested and Lloyd's certified to 700°C (1300°F) in accordance with API 16D. Certificate available upon request.**

- Use H-Series dust caps and dust plugs found on pages 8-9.

M

### Rated Pressure Chart:

H-BOP-SERIES BLOWOUT PREVENTION SAFETY INTERCHANGE										
BODY SIZE	STEEL COUPLER/PLUG				316 STAINLESS STEEL COUPLER/PLUG				LLOYD'S TEST PRESSURE	FLOW ΔP = 22 PSI
	Maximum Working		Burst		Maximum Working		Burst			
	PSI	MPA	PSI	MPA	PSI	MPA	PSI	MPA		
1/2"	5,000	345	16,000	1,100	5,000	345	22,000	1,500	5,000	56
3/4"	5,000	345	16,500	1,150	5,000	345	21,500	1,450	5,000	109
1"	5,000	345	16,000	1,100	5,000	345	15,000	1,000	5,000	188



# Quick Release Couplings

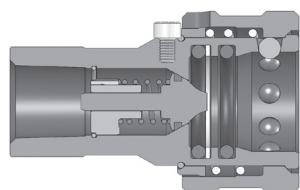
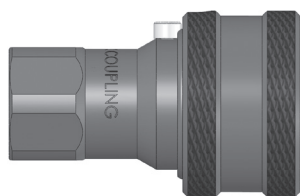

(Female Thread)

## H-BOP SERIES BLOWOUT PREVENTION SAFETY COUPLER

PART NO	BODY SIZE	THREAD SIZE	BODY MATERIAL
4HF4-BOP	1/2"	1/2" - 14 NPTF	Steel
4HF4-SS-BOP	1/2"	1/2" - 14 NPTF	316 Stainless Steel
6HF6-BOP	3/4"	3/4" - 14 NPTF	Steel
6HF6-SS-BOP	3/4"	3/4" - 14 NPTF	316 Stainless Steel
8HF8-BOP	1"	1" - 11 1/2 NPTF	Steel
8HF8-SS-BOP	1"	1" - 11 1/2 NPTF	316 Stainless Steel

M

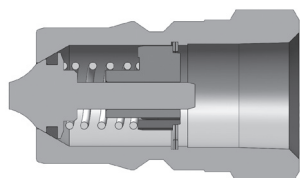

(Female Thread)

## H-BOP SERIES BLOWOUT PREVENTION SAFETY NIPPLE

PART NO	BODY SIZE	THREAD SIZE	BODY MATERIAL
H4F4-BOP	1/2"	1/2" - 14 NPTF	Steel
H4F4-SS-BOP	1/2"	1/2" - 14 NPTF	316 Stainless Steel
H6F6-BOP	3/4"	3/4" - 14 NPTF	Steel
H6F6-SS-BOP	3/4"	3/4" - 14 NPTF	316 Stainless Steel
H8F8-BOP	1"	1" - 11 1/2 NPTF	Steel
H8F8-SS-BOP	1"	1" - 11 1/2 NPTF	316 Stainless Steel



## PD-Series ISO15171-1 Diagnostic Interchange

### Interchange Data:

- Interchangeable to ISO15171-1
- Parker PD-Series, Aeroquip FD90, Tomco Series DK

### Materials:

- Machined components are manufactured using solid Steel bar stock
- Stainless Steel balls, retaining rings, and springs maximise corrosion resistance and extend service life
- Steel nipples are machined from solid Steel bar stock and hardened
- Steel componentry is plated using ROHS Compliant Trivalent Chrome



### Seal Components:

- Nitrile (Buna-N) seals are standard, providing a temperature range of -40°C to +121°C (-40°F to +250°F)
- PTFE anti-extrusion ring protects main coupler O-Ring from dynamic impulse pressure damage

### Rated Pressure Chart:

PD-SERIES ISO15171-1 DIAGNOSTIC INTERCHANGE								
BODY SIZE	STEEL COUPLER/PLUG CONNECTED				STEEL PLUG DISCONNECTED			
	Max. Working		Burst		Max. Working		Burst	
	PSI	Bar	PSI	Bar	PSI	Bar	PSI	Bar
1/8"	6,000	400	18,700	1,300	6,000	400	24,000	1,600



### Technical Specifications:

BODY SIZE	INTERCHANGE STANDARDS				FUNCTIONAL PARAMETERS				
	U.S. MILITARY	U.S. GOVERNMENT	INTERNATIONAL STANDARDS	ANSI/NFPA STANDARDS	LOCKING BALL QUANTITY	AIR INCLUSION	FLUID LOSS	VACUUM INCH HG	FLOW ΔP = 22 PSI L/MIN
1/8"	-	-	ISO15171-1	SAE J1502	10	0.02	0.1	27.4	3

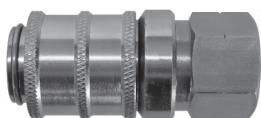

(Female Thread)

### PD-SERIES ISO15171-1 DIAGNOSTIC INTERCHANGE (COUPLER)

PART NO.	BODY SIZE	THREAD SIZE	BODY MATERIAL
1PDF1	1/8"	1/8"- 27 NPTF	Steel
1PDF2	1/8"	1/4"-18 NPTF	Steel

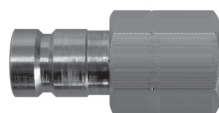

(Female Thread)

### PD-SERIES ISO15171-1 DIAGNOSTIC INTERCHANGE (NIPPLE)

PART NO.	BODY SIZE	THREAD SIZE	BODY MATERIAL
PD1F1	1/8"	1/8"- 27 NPTF	Steel
PD1F2	1/8"	1/4"-18 NPTF	Steel



## V-Series Hydraulic Coupling

### Interchange Data:

- Interchangeable to MIL-C-51234
- Snap-Tite H/IH and Faster TNV/TNL

### Materials:

- Machined components are manufactured using solid Steel, Brass, or 316 Stainless Steel bar stock
- Stainless Steel balls, retaining rings, and springs maximise corrosion resistance and extend service life
- Steel componentry is plated using ROHS Compliant Trivalent Chrome
- Steel coupler sleeves are hardened to resist deformation and maximise service life
- Steel nipples are machined from high-strength Steel and induction hardened
- Tubular 'TV' valves are constructed from Steel bar stock and are designed for optimum performance in pneumatic applications



### Seal Components:

- Nitrile (Buna-N) seals are standard, providing a temperature range of -40°C to +121°C (-40°F to +250°F)
- All couplers incorporate a PTFE anti-extrusion ring to protect the seal components from dynamic impulse damage
- 1/4" to 1" valve seals are crimped in place to maintain integrity during excessive flow conditions and pressurised connection
- 1 1/4" to 2" valve O-rings are retained by a unique seal-groove profile and are field replaceable

### Rated Pressure Chart:

**V-SERIES SNAP-TITE H/IH INTERCHANGE (VALVED CONNECTED)**

BODY SIZE	STEEL COUPLER/PLUG				BRASS COUPLER/PLUG				316 STAINLESS COUPLER/PLUG			
	Max. Working		Burst		Max. Working		Burst		Max. Working		Burst	
	PSI	Bar	PSI	Bar	PSI	Bar	PSI	Bar	PSI	Bar	PSI	Bar
1/4"	6,500	450	12,700	876	2,250	150	5,000	345	5,000	345	10,000	700
3/8"	4,500	310	10,500	700	2,250	150	5,300	350	4,000	275	8,000	550
1/2"	4,000	275	9,600	650	2,000	130	5,700	390	3,750	260	7,500	500
3/4"	3,500	240	9,100	600	2,000	130	5,300	350	2,000	130	7,500	500
1"	2,000	130	9,500	650	1,750	120	5,000	345	2,000	130	5,000	345
1 1/4"	1,750	120	5,000	345	350	24	1,000	70	1,500	100	3,000	200
1 1/2"	1,500	100	5,000	345	350	24	1,200	80	1,500	100	3,000	200
2"	1,500	100	4,000	275	400	28	1,000	70	500	34	1,000	70

**V-SERIES SNAP-TITE H/IH INTERCHANGE (UNVALVED CONNECTED)**

BODY SIZE	STEEL COUPLER/PLUG				BRASS COUPLER/PLUG				316 STAINLESS COUPLER/PLUG			
	Max. Working		Burst		Max. Working		Burst		Max. Working		Burst	
	PSI	Bar	PSI	Bar	PSI	Bar	PSI	Bar	PSI	Bar	PSI	Bar
1/4"	11,000	760	29,500	2,000	4,000	275	14,200	980	10,000	670	29,200	2,000
3/8"	11,000	760	29,900	2,000	4,000	275	14,500	1,000	8,000	550	27,900	1,900
1/2"	11,000	760	29,300	2,000	4,000	275	14,500	1,000	8,000	550	24,600	1,700
3/4"	9,000	620	19,300	1,300	3,500	250	11,100	750	7,000	480	22,600	1,500
1"	6,000	400	15,900	1,100	3,000	200	8,200	560	4,000	275	15,500	1,000
1 1/4"	5,000	345	10,000	700	1,000	70	4,000	275	3,000	200	10,000	700
1 1/2"	5,000	345	10,000	700	1,000	70	4,000	275	3,000	200	10,000	700
2"	4,000	275	8,000	550	750	50	2,800	190	1,000	70	6,000	400

## Technical Specifications:

BODY SIZE	INTERCHANGE STANDARDS			FUNCTIONAL PARAMETERS				
	U.S. MILITARY	INTERNATIONAL STANDARDS	ANSI/NFPA STANDARDS	LOCKING BALL QUANTITY	AIR INCLUSION	FLUID LOSS	VACUUM INCH HG	FLOW $\Delta P = 22$ PSI L/MIN
1/4"	MIL-C-51234	-	-	6	2.0cc	0.2cc	26.7	19
3/8"	MIL-C-51234	-	-	6	3.5cc	3.2cc	26.7	34
1/2"	MIL-C-51234	-	-	9	4.0cc	4.0cc	26.7	49
3/4"	MIL-C-51234	-	-	9	14.0cc	14.0cc	26.7	113
1"	MIL-C-51234	-	-	12	21.0cc	20.0cc	26.7	180
1 1/4"	MIL-C-51234	-	-	12	45.0cc	45.0cc	N/R	308
1 1/2"	MIL-C-51234	-	-	12	80.0cc	80.0cc	N/R	451
2"	MIL-C-51234	-	-	12	150.0cc	150.0cc	N/R	696

Note: Minimum burst pressure ratings were established under laboratory conditions using a Static Burst Unit (SBU). For high impulse applications and to meet Det Norske Veritas (DNV) compliance, the operating pressure must be divided by two (2) to ensure a 4:1 safety factor during system operation.

## V-SERIES DUST CAPS AND DUST PLUGS



PART NO		BODY SIZE	BODY MATERIAL
COUPLER DUST PLUG	NIPPLE DUST CAP		
1HDP	V2DC	1/4"	Nitrile
3VDP-V3DC	Combo dust cap/plug	3/8"	Nitrile
3KDP-K3DC	Combo dust cap/plug	1/2"	Nitrile
6VDP-V6DC	Combo dust cap/plug	3/4"	Nitrile
8VDP-V8DC	Combo dust cap/plug	1"	Nitrile

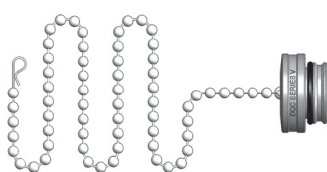

## V-SERIES SNAP-TITE 'H' INTERCHANGE (COUPLER RIGID DUST PLUG)

PART NO.	BODY SIZE	LANYARD	BODY MATERIAL
2VDP-A	1/4"	SS Bead Chain	Aluminium
3VDP-A	3/8"	SS Bead Chain	Aluminium
4VDP-A	1/2"	SS Bead Chain	Aluminium
6VDP-A	3/4"	SS Bead Chain	Aluminium
8VDP-A	1"	SS Bead Chain	Aluminium
10VDP-A	1 1/4"	SS Bead Chain	Aluminium
12VDP-A	1 1/2"	SS Bead Chain	Aluminium
16VDP-A	2"	SS Bead Chain	Aluminium

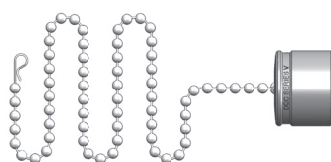

## V-SERIES SNAP-TITE 'H' INTERCHANGE (NIPPLE RIGID DUST CAP)

PART NO.	BODY SIZE	LANYARD	BODY MATERIAL
V2DC-A	1/4"	SS Bead Chain	Aluminium
V3DC-A	3/8"	SS Bead Chain	Aluminium
V4DC-A	1/2"	SS Bead Chain	Aluminium
V6DC-A	3/4"	SS Bead Chain	Aluminium
V8DC-A	1"	SS Bead Chain	Aluminium
V10DC-A	1 1/4"	SS Bead Chain	Aluminium
V12DC-A	1 1/2"	SS Bead Chain	Aluminium
V16DC-A	2"	SS Bead Chain	Aluminium

# Quick Release Couplings

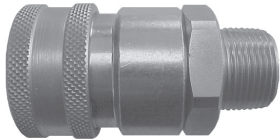

(Male Thread)

## V-SERIES SNAP-TITE 'H' INTERCHANGE (VALVED COUPLER)

PART NO.	BODY SIZE	THREAD SIZE	BODY MATERIAL
2VM1	1/4"	1/8"-27 NPTF	Steel
2VM2	1/4"	1/4"-18 NPTF	Steel
2VM2-B	1/4"	1/4"-18 NPTF	Brass
2VM2-SS	1/4"	1/4"-18 NPTF	316 Stainless Steel
2VJM2	1/4"	7/16"-20 JIC	Steel
3VM3	3/8"	3/8"-18 NPTF	Steel
3VM3-B	3/8"	3/8"-18 NPTF	Brass
3VM3-SS	3/8"	3/8"-18 NPTF	316 Stainless Steel
3VJM3	3/8"	9/16"-18 JIC	Steel
4VM4	1/2"	1/2"-14 NPTF	Steel
4VM4-B	1/2"	1/2"-14 NPTF	Brass
4VM4-SS	1/2"	1/2"-14 NPTF	316 Stainless Steel
4VJM4	1/2"	3/4"-16 JIC	Steel
6VM6	3/4"	3/4"-14 NPTF	Steel
6VM6-B	3/4"	3/4"-14 NPTF	Brass
6VM6-SS	3/4"	3/4"-14 NPTF	316 Stainless Steel
6VJM6	3/4"	1 1/16"-12 JIC	Steel
8VM8	1"	1"-11 1/2 NPTF	Steel
8VM8-B	1"	1"-11 1/2 NPTF	Brass
8VM8-SS	1"	1"-11 1/2 NPTF	316 Stainless Steel
8VJM8	1"	1 5/16"-12 JIC	Steel
10VM10	1 1/4"	1 1/4"-11 1/2 NPTF	Steel
10VM10-B	1 1/4"	1 1/4"-11 1/2 NPTF	Brass
10VM10-SS	1 1/4"	1 1/4"-11 1/2 NPTF	316 Stainless Steel
10VJM10	1 1/4"	1 5/8"-12 JIC	Steel
12VM12	1 1/2"	1 1/2"-11 1/2 NPTF	Steel
12VM12-B	1 1/2"	1 1/2"-11 1/2 NPTF	Brass
12VM12-SS	1 1/2"	1 1/2"-11 1/2 NPTF	316 Stainless Steel
12VJM12	1 1/2"	1 - 7/8"-12 JIC	Steel
16VM16	2"	2"-11 1/2 NPTF	Steel
16VM16-B	2"	2"-11 1/2 NPTF	Brass
16VM16-SS	2"	2"-11 1/2 NPTF	316 Stainless Steel

## V-SERIES SNAP-TITE 'H' INTERCHANGE (VALVED NIPPLE)

PART NO.	BODY SIZE	THREAD SIZE	BODY MATERIAL
V2M1	1/4"	1/8"-27 NPTF	Steel
V2M2	1/4"	1/4"-18 NPTF	Steel
V2M2-B	1/4"	1/4"-18 NPTF	Brass
V2M2-SS	1/4"	1/4"-18 NPTF	316 Stainless Steel
V2JM2	1/4"	7/16"-20 JIC	Steel
V3M3	3/8"	3/8"-18 NPTF	Steel
V3M3-B	3/8"	3/8"-18 NPTF	Brass
V3M3-SS	3/8"	3/8"-18 NPTF	316 Stainless Steel
V3JM3	3/8"	9/16"-18 JIC	Steel
V4M4	1/2"	1/2"-14 NPTF	Steel
V4M4-B	1/2"	1/2"-14 NPTF	Brass
V4M4-SS	1/2"	1/2"-14 NPTF	316 Stainless Steel
V4JM4	1/2"	3/4"-16 JIC	Steel
V6M6	3/4"	3/4"-14 NPTF	Steel
V6M6-B	3/4"	3/4"-14 NPTF	Brass
V6M6-SS	3/4"	3/4"-14 NPTF	316 Stainless Steel
V6JM6	3/4"	1 1/16"-12 JIC	Steel
V8M8	1"	1"-11 1/2 NPTF	Steel
V8M8-B	1"	1"-11 1/2 NPTF	Brass
V8M8-SS	1"	1"-11 1/2 NPTF	316 Stainless Steel
V8JM8	1"	1 - 5/16"-12 JIC	Steel
V10M10	1 1/4"	1 1/4"-11 1/2 NPTF	Steel
V10M10-B	1 1/4"	1 1/4"-11 1/2 NPTF	Brass
V10M10-SS	1 1/4"	1 1/4"-11 1/2 NPTF	316 Stainless Steel
V10JM10	1 1/4"	1 5/8"-12 JIC	Steel
V12M12	1 1/2"	1 1/2"-11 1/2 NPTF	Steel
V12M12-B	1 1/2"	1 1/2"-11 1/2 NPTF	Brass
V12M12-SS	1 1/2"	1 1/2"-11 1/2 NPTF	316 Stainless Steel
V12JM12	1 1/2"	1 7/8"-12 JIC	Steel
V16M16	2"	2"-11 1/2 NPTF	Steel
V16M16-B	2"	2"-11 1/2 NPTF	Brass
V16M16-SS	2"	2"-11 1/2 NPTF	316 Stainless Steel

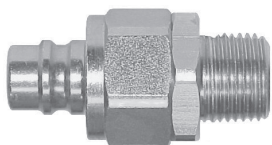

(Male Thread)

## V-SERIES SNAP-TITE 'H' INTERCHANGE (VALVED COUPLER)

PART NO.	BODY SIZE	THREAD SIZE	BODY MATERIAL
2VF1	1/4"	1/8"-27 NPTF	Steel
2VF2	1/4"	1/4"-18 NPTF	Steel
2VF2-B	1/4"	1/4"-18 NPTF	Brass
2VF2-SS	1/4"	1/4"-18 NPTF	316 Stainless Steel
2VOF2	1/4"	7/16"-20 ORB	Steel
2VBF2	1/4"	1/4"-19 BSPP	Steel
2VBF2-B	1/4"	1/4"-19 BSPP	Brass
2VBF2-SS	1/4"	1/4"-19 BSPP	316 Stainless Steel
3VF3	3/8"	3/8"-18 NPTF	Steel
3VF3-B	3/8"	3/8"-18 NPTF	Brass
3VF3-SS	3/8"	3/8"-18 NPTF	316 Stainless Steel
3VOF3	3/8"	9/16"-18 ORB	Steel
3VBF3	3/8"	3/8"-19 BSPP	Steel
3VBF3-B	3/8"	3/8"-19 BSPP	Brass
3VBF3-SS	3/8"	3/8"-19 BSPP	316 Stainless Steel
3VF4	3/8"	1/2"-14 NPTF	Steel
4VF4	1/2"	1/2"-14 NPTF	Steel
4VF4-B	1/2"	1/2"-14 NPTF	Brass
4VF4-SS	1/2"	1/2"-14 NPTF	316 Stainless Steel
4VOF4	1/2"	3/4"-16 ORB	Steel
4VBF4	1/2"	1/2"-14 BSPP	Steel
4VBF4-B	1/2"	1/2"-14 BSPP	Brass
4VBF4-SS	1/2"	1/2"-14 BSPP	316 Stainless Steel
4VF6	1/2"	3/4"-14 NPTF	Steel
6VF6	3/4"	3/4"-14 NPTF	Steel
6VF6-B	3/4"	3/4"-14 NPTF	Brass
6VF6-SS	3/4"	3/4"-14 NPTF	316 Stainless Steel
6VOF6	3/4"	1 1/16"-12 ORB	Steel
6VBF6	3/4"	3/4"-14 BSPP	Steel
6VBF6-B	3/4"	3/4"-14 BSPP	Brass
6VBF6-SS	3/4"	3/4"-14 BSPP	316 Stainless Steel
8VF8	1"	1"-11 1/2 NPTF	Steel
8VF8-B	1"	1"-11 1/2 NPTF	Brass
8VF8-SS	1"	1"-11 1/2 NPTF	316 Stainless Steel
8VOF8	1"	15/16"-12 ORB	Steel
8VBF8	1"	1"-11 BSPP	Steel
8VBF8-B	1"	1"-11 BSPP	Brass
8VBF8-SS	1"	1"-11 BSPP	316 Stainless Steel
10VF10	1 1/4"	1 1/4"-11 1/2 NPTF	Steel
10VF10-B	1 1/4"	1 1/4"-11 1/2 NPTF	Brass
10VF10-SS	1 1/4"	1 1/4"-11 1/2 NPTF	316 Stainless Steel
10VOF10	1 1/4"	15/8"-12 ORB	Steel
10VBF10	1 1/4"	1 1/4"-11 BSPP	Steel
10VBF10-B	1 1/4"	1 1/4"-11 BSPP	Brass
10VBF10-SS	1 1/4"	1 1/4"-11 BSPP	316 Stainless Steel
12VF12	1 1/2"	1 1/2"-11 1/2 NPTF	Steel
12VF12-B	1 1/2"	1 1/2"-11 1/2 NPTF	Brass
12VF12-SS	1 1/2"	1 1/2"-11 1/2 NPTF	316 Stainless Steel
12VOF12	1 1/2"	1 7/8"-12 ORB	Steel
12VBF12	1 1/2"	1 1/2"-11 BSPP	Steel
12VBF12-B	1 1/2"	1 1/2"-11 BSPP	Brass
12VBF12-SS	1 1/2"	1 1/2"-11 BSPP	316 Stainless Steel
16VF16	2"	2"-11 1/2 NPTF	Steel
16VF16-B	2"	2"-11 1/2 NPTF	Brass
16VF16-SS	2"	2"-11 1/2 NPTF	316 Stainless Steel
16VBF16	2"	2"-11 BSPP	Steel
16VBF16-B	2"	2"-11 BSPP	Brass
16VBF16-SS	2"	2"-11 BSPP	316 Stainless Steel

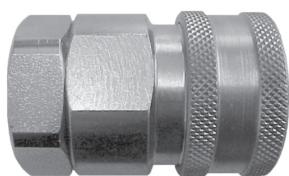

(Female Thread)

## V-SERIES SNAP-TITE 'H' INTERCHANGE (VALVED NIPPLE)

PART NO.	BODY SIZE	THREAD SIZE	BODY MATERIAL
V2F1	1/4"	1/8"-27 NPTF	Steel
V2F2	1/4"	1/4"-18 NPTF	Steel
V2F2-B	1/4"	1/4"-18 NPTF	Brass
V2F2-SS	1/4"	1/4"-18 NPTF	316 Stainless Steel
V2OF2	1/4"	7/16"-20 ORB	Steel
V2BF2	1/4"	1/4"-19 BSPP	Steel
V2BF2-B	1/4"	1/4"-19 BSPP	Brass
V2BF2-SS	1/4"	1/4"-19 BSPP	316 Stainless Steel
V3F3	3/8"	3/8"-18 NPTF	Steel
V3F3-B	3/8"	3/8"-18 NPTF	Brass
V3F3-SS	3/8"	3/8"-18 NPTF	316 Stainless Steel
V3OF3	3/8"	9/16"-18 ORB	Steel
V3BF3	3/8"	3/8"-19 BSPP	Steel
V3BF3-B	3/8"	3/8"-19 BSPP	Brass
V3BF3-SS	3/8"	3/8"-19 BSPP	316 Stainless Steel
V3F4	3/8"	1/2"-14 NPTF	Steel
V4F4	1/2"	1/2"-14 NPTF	Steel
V4F4-B	1/2"	1/2"-14 NPTF	Brass
V4F4-SS	1/2"	1/2"-14 NPTF	316 Stainless Steel
V4OF4	1/2"	3/4"-16 ORB	Steel
V4BF4	1/2"	1/2"-14 BSPP	Steel
V4BF4-B	1/2"	1/2"-14 BSPP	Brass
V4BF4-SS	1/2"	1/2"-14 BSPP	316 Stainless Steel
V4F6	1/2"	3/4"-14 NPTF	Steel
V6F6	3/4"	3/4"-14 NPTF	Steel
V6F6-B	3/4"	3/4"-14 NPTF	Brass
V6F6-SS	3/4"	3/4"-14 NPTF	316 Stainless Steel
V6OF6	3/4"	1 1/16"-12 ORB	Steel
V6BF6	3/4"	3/4"-14 BSPP	Steel
V6BF6-B	3/4"	3/4"-14 BSPP	Brass
V6BF6-SS	3/4"	3/4"-14 BSPP	316 Stainless Steel
V8F8	1"	1"-11 1/2 NPTF	Steel
V8F8-B	1"	1"-11 1/2 NPTF	Brass
V8F8-SS	1"	1"-11 1/2 NPTF	316 Stainless Steel
V8OF8	1"	1 5/16"-12 ORB	Steel
V8BF8	1"	1"-11 BSPP	Steel
V8BF8-B	1"	1"-11 BSPP	Brass
V8BF8-SS	1"	1"-11 BSPP	316 Stainless Steel
V10F10	1 1/4"	1 1/4"-11 1/2 NPTF	Steel
V10F10-B	1 1/4"	1 1/4"-11 1/2 NPTF	Brass
V10F10-SS	1 1/4"	1 1/4"-11 1/2 NPTF	316 Stainless Steel
V10OF10	1 1/4"	1 5/8"-12 ORB	Steel
V10BF10	1 1/4"	1 1/4"-11 BSPP	Steel
V10BF10-B	1 1/4"	1 1/4"-11 BSPP	Brass
V10BF10-SS	1 1/4"	1 1/4"-11 BSPP	316 Stainless Steel
V12F12	1 1/2"	1 1/2"-11 1/2 NPTF	Steel
V12F12-B	1 1/2"	1 1/2"-11 1/2 NPTF	Brass
V12F12-SS	1 1/2"	1 1/2"-11 1/2 NPTF	316 Stainless Steel
V12OF12	1 1/2"	1 7/8"-12 ORB	Steel
V12BF12	1 1/2"	1 1/2"-11 BSPP	Steel
V12BF12-B	1 1/2"	1 1/2"-11 BSPP	Brass
V12BF12-SS	1 1/2"	1 1/2"-11 BSPP	316 Stainless Steel
V16F16	2"	2"-11 1/2 NPTF	Steel
V16F16-B	2"	2"-11 1/2 NPTF	Brass
V16F16-SS	2"	2"-11 1/2 NPTF	316 Stainless Steel
V16BF16	2"	2"-11 BSPP	Steel
V16BF16-B	2"	2"-11 BSPP	Brass
V16BF16-SS	2"	2"-11 BSPP	316 Stainless Steel

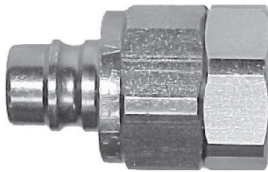

(Female Thread)

## V-SERIES SNAP-TITE 'H' INTERCHANGE (UNVALVED COUPLER)

PART NO.	BODY SIZE	THREAD SIZE	BODY MATERIAL
2VF2-E	1/4"	1/4"-18 NPTF	Steel
2VF2-B-E	1/4"	1/4"-18 NPTF	Brass
2VF2-SS-E	1/4"	1/4"-18 NPTF	316 Stainless Steel
2VBF2-E	1/4"	1/4"-19 BSPP	Steel
2VBF2-B-E	1/4"	1/4"-19 BSPP	Brass
2VBF2-SS-E	1/4"	1/4"-19 BSPP	316 Stainless Steel
3VF3-E	3/8"	3/8"-18 NPTF	Steel
3VF3-B-E	3/8"	3/8"-18 NPTF	Brass
3VF3-SS-E	3/8"	3/8"-18 NPTF	316 Stainless Steel
3VBF3-E	3/8"	3/8"-19 BSPP	Steel
3VBF3-B-E	3/8"	3/8"-19 BSPP	Brass
3VBF3-SS-E	3/8"	3/8"-19 BSPP	316 Stainless Steel
4VF4-E	1/2"	1/2"-14 NPTF	Steel
4VF4-B-E	1/2"	1/2"-14 NPTF	Brass
4VF4-SS-E	1/2"	1/2"-14 NPTF	316 Stainless Steel
4VBF4-E	1/2"	1/2"-14 BSPP	Steel
4VBF4-B-E	1/2"	1/2"-14 BSPP	Brass
4VBF4-SS-E	1/2"	1/2"-14 BSPP	316 Stainless Steel
6VF6-E	3/4"	3/4"-14 NPTF	Steel
6VF6-B-E	3/4"	3/4"-14 NPTF	Brass
6VF6-SS-E	3/4"	3/4"-14 NPTF	316 Stainless Steel
6VBF6-E	3/4"	3/4"-14 BSPP	Steel
6VBF6-B-E	3/4"	3/4"-14 BSPP	Brass
6VBF6-SS-E	3/4"	3/4"-14 BSPP	316 Stainless Steel
8VF8-E	1"	1"-11 1/2 NPTF	Steel
8VF8-B-E	1"	1"-11 1/2 NPTF	Brass
8VF8-SS-E	1"	1"-11 1/2 NPTF	316 Stainless Steel
8VBF8-E	1"	1"-14 BSPP	Steel
8VBF8-B-E	1"	1"-14 BSPP	Brass
8VBF8-SS-E	1"	1"-14 BSPP	316 Stainless Steel
10VF10-E	1 1/4"	1 1/4"-11 1/2 NPTF	Steel
10VF10-B-E	1 1/4"	1 1/4"-11 1/2 NPTF	Brass
10VF10-SS-E	1 1/4"	1 1/4"-11 1/2 NPTF	316 Stainless Steel
10VBF10-E	1 1/4"	1 1/4"-11 BSPP	Steel
10VBF10-B-E	1 1/4"	1 1/4"-11 BSPP	Brass
10VBF10-SS-E	1 1/4"	1 1/4"-11 BSPP	316 Stainless Steel
12VF12-E	1 1/2"	1 1/2"-11 1/2 NPTF	Steel
12VF12-B-E	1 1/2"	1 1/2"-11 1/2 NPTF	Brass
12VF12-SS-E	1 1/2"	1 1/2"-11 1/2 NPTF	316 Stainless Steel
12VBF12-E	1 1/2"	1 1/2"-11 BSPP	Steel
12VBF12-B-E	1 1/2"	1 1/2"-11 BSPP	Brass
12VBF12-SS-E	1 1/2"	1 1/2"-11 BSPP	316 Stainless Steel
16VF16-E	2"	2"-11 1/2 NPTF	Steel
16VF16-B-E	2"	2"-11 1/2 NPTF	Brass
16VF16-SS-E	2"	2"-11 1/2 NPTF	316 Stainless Steel
16VBF16-E	2"	2"-11 BSPP	Steel
16VBF16-B-E	2"	2"-11 BSPP	Brass
16VBF16-SS-E	2"	2"-11 BSPP	316 Stainless Steel

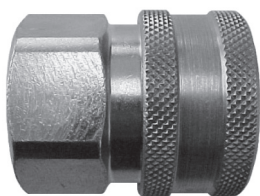

(Female Thread)

## V-SERIES SNAP-TITE 'H' INTERCHANGE (UNVALVED COUPLER)

PART NO.	BODY SIZE	THREAD SIZE	BODY MATERIAL
2VM2-E	1/4"	1/4"-18 NPTF	Steel
2VM2-B-E	1/4"	1/4"-18 NPTF	Brass
2VM2-SS-E	1/4"	1/4"-18 NPTF	316 Stainless Steel
3VM3-E	3/8"	3/8"-18 NPTF	Steel
3VM3-B-E	3/8"	3/8"-18 NPTF	Brass
3VM3-SS-E	3/8"	3/8"-18 NPTF	316 Stainless Steel
4VM4-E	1/2"	1/2"-14 NPTF	Steel
4VM4-B-E	1/2"	1/2"-14 NPTF	Brass
4VM4-SS-E	1/2"	1/2"-14 NPTF	316 Stainless Steel
6VM6-E	3/4"	3/4"-14 NPTF	Steel
6VM6-B-E	3/4"	3/4"-14 NPTF	Brass
6VM6-SS-E	3/4"	3/4"-14 NPTF	316 Stainless Steel
8VM8-E	1"	1"-11 1/2 NPTF	Steel
8VM8-B-E	1"	1"-11 1/2 NPTF	Brass
8VM8-SS-E	1"	1"-11 1/2 NPTF	316 Stainless Steel
10VM10-E	1 1/4"	1 1/4"-11 1/2 NPTF	Steel
10VM10-SS-E	1 1/4"	1 1/4"-11 1/2 NPTF	316 Stainless Steel
12VM12-E	1 1/2"	1 1/2"-11 1/2 NPTF	Steel
12VM12-SS-E	1 1/2"	1 1/2"-11 1/2 NPTF	316 Stainless Steel
16VM16-E	2"	2"-11 1/2 NPTF	Steel
16VM16-SS-E	2"	2"-11 1/2 NPTF	316 Stainless Steel

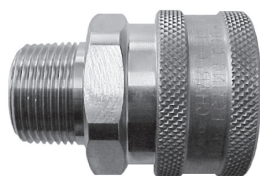

(Male Thread)

# Quick Release Couplings

## V-SERIES SNAP-TITE 'H' INTERCHANGE (UNVALVED NIPPLE)

PART NO.	BODY SIZE	THREAD SIZE	BODY MATERIAL
V2F2-E	1/4"	1/4"-18 NPTF	Steel
V2F2-B-E	1/4"	1/4"-18 NPTF	Brass
V2F2-SS-E	1/4"	1/4"-18 NPTF	316 Stainless Steel
V2BF2-E	1/4"	1/4"-19 BSPP	Steel
V2BF2-B-E	1/4"	1/4"-19 BSPP	Brass
V2BF2-SS-E	1/4"	1/4"-19 BSPP	316 Stainless Steel
V3F3-E	3/8"	3/8"-18 NPTF	Steel
V3F3-B-E	3/8"	3/8"-18 NPTF	Brass
V3F3-SS-E	3/8"	3/8"-18 NPTF	316 Stainless Steel
V3BF3-E	3/8"	3/8"-19 BSPP	Steel
V3BF3-B-E	3/8"	3/8"-19 BSPP	Brass
V3BF3-SS-E	3/8"	3/8"-19 BSPP	316 Stainless Steel
V4F4-E	1/2"	1/2"-14 NPTF	Steel
V4F4-B-E	1/2"	1/2"-14 NPTF	Brass
V4F4-SS-E	1/2"	1/2"-14 NPTF	316 Stainless Steel
V4BF4-E	1/2"	1/2"-14 BSPP	Steel
V4BF4-B-E	1/2"	1/2"-14 BSPP	Brass
V4BF4-SS-E	1/2"	1/2"-14 BSPP	316 Stainless Steel
V6F6-E	3/4"	3/4"-14 NPTF	Steel
V6F6-B-E	3/4"	3/4"-14 NPTF	Brass
V6F6-SS-E	3/4"	3/4"-14 NPTF	316 Stainless Steel
V6BF6-E	3/4"	3/4"-14 BSPP	Steel
V6BF6-B-E	3/4"	3/4"-14 BSPP	Brass
V6BF6-SS-E	3/4"	3/4"-14 BSPP	316 Stainless Steel
V8F8-E	1"	1"-11 1/2 NPTF	Steel
V8F8-B-E	1"	1"-11 1/2 NPTF	Brass
V8F8-SS-E	1"	1"-11 1/2 NPTF	316 Stainless Steel
V8BF8-E	1"	1"-11 BSPP	Steel
V8BF8-B-E	1"	1"-11 BSPP	Brass
V8BF8-SS-E	1"	1"-11 BSPP	316 Stainless Steel
V10F10-E	1 1/4"	1 1/4"-11 1/2 NPTF	Steel
V10F10-B-E	1 1/4"	1 1/4"-11 1/2 NPTF	Brass
V10F10-SS-E	1 1/4"	1 1/4"-11 1/2 NPTF	316 Stainless Steel
V10BF10-E	1 1/4"	1 1/4"-11 BSPP	Steel
V10BF10-B-E	1 1/4"	1 1/4"-11 BSPP	Brass
V10BF10-SS-E	1 1/4"	1 1/4"-11 BSPP	316 Stainless Steel
V12F12-E	1 1/2"	1 1/2"-11 1/2 NPTF	Steel
V12F12-B-E	1 1/2"	1 1/2"-11 1/2 NPTF	Brass
V12F12-SS-E	1 1/2"	1 1/2"-11 1/2 NPTF	316 Stainless Steel
V12BF12-E	1 1/2"	1 1/2"-11 BSPP	Steel
V12BF12-B-E	1 1/2"	1 1/2"-11 BSPP	Brass
V12BF12-SS-E	1 1/2"	1 1/2"-11 BSPP	316 Stainless Steel
V16F16-E	2"	2"-11 1/2 NPTF	Steel
V16F16-B-E	2"	2"-11 1/2 NPTF	Brass
V16F16-SS-E	2"	2"-11 1/2 NPTF	316 Stainless Steel
V16BF16-E	2"	2"-11 BSPP	Steel
V16BF16-B-E	2"	2"-11 BSPP	Brass
V16BF16-SS-E	2"	2"-11 BSPP	316 Stainless Steel



(Female Thread)

O

## V-SERIES SNAP-TITE 'H' INTERCHANGE (UNVALVED NIPPLE)

PART NO.	BODY SIZE	THREAD SIZE	BODY MATERIAL
V2M2-E	1/4"	1/4"-18 NPTF	Steel
V2M2-B-E	1/4"	1/4"-18 NPTF	Brass
V2M2-SS-E	1/4"	1/4"-18 NPTF	316 Stainless Steel
V3M3-E	3/8"	3/8"-18 NPTF	Steel
V3M3-B-E	3/8"	3/8"-18 NPTF	Brass
V3M3-SS-E	3/8"	3/8"-18 NPTF	316 Stainless Steel
V4M4-E	1/2"	1/2"-14 NPTF	Steel
V4M4-B-E	1/2"	1/2"-14 NPTF	Brass
V4M4-SS-E	1/2"	1/2"-14 NPTF	316 Stainless Steel
V6M6-E	3/4"	3/4"-14 NPTF	Steel
V6M6-B-E	3/4"	3/4"-14 NPTF	Brass
V6M6-SS-E	3/4"	3/4"-14 NPTF	316 Stainless Steel
V8M8-E	1"	1"-11 1/2 NPTF	Steel
V8M8-B-E	1"	1"-11 1/2 NPTF	Brass
V8M8-SS-E	1"	1"-11 1/2 NPTF	316 Stainless Steel
V10M10-E	1 1/4"	1 1/4"-11 1/2 NPTF	Steel
V10M10-SS-E	1 1/4"	1 1/4"-11 1/2 NPTF	316 Stainless Steel
V12M12-E	1 1/2"	1 1/2"-11 1/2 NPTF	Steel
V12M12-SS-E	1 1/2"	1 1/2"-11 1/2 NPTF	316 Stainless Steel
V16M16-E	2"	2"-11 1/2 NPTF	Steel
V16M16-SS-E	2"	2"-11 1/2 NPTF	316 Stainless Steel



(Male Thread)



## T-Series High Pressure Screw-Together

### Interchange Data:

- High Pressure Screw-Together Interchange
- Parker/Pioneer 3000-Series, Enerpac C604, Stucchi IVHP
- Hansen WS56000, Snap-Tite 76-Series, DNP PVM

### Materials:

- Machined components are manufactured using solid Steel or 316 Stainless Steel bar stock
- Chrome Steel ball valve is mechanically seated to improve low pressure sealing performance
- Steel nipples are machined from solid high strength Steel bar stock
- Steel componentry is plated using ROHS Compliant Trivalent Chrome



### Seal Components:

- Urethane seal is standard in ball valve couplers and provides resistance to extrusion when subjected to high pressure - temperature range -40°C to +82°C (-40°F to +180°F)
- Nitrile seals are standard in poppet valve couplings, providing a temperature range of -40°C to +121°C (-40°F to +250°F)

### Rated Pressure Chart:

T-SERIES HIGH PRESSURE ENERPAC INTERCHANGE (CONNECTED)																
BODY SIZE	STEEL BALL COUPLER/PLUG				316 STAINLESS STEEL BALL COUPLER/PLUG				STEEL POPPET COUPLER/PLUG				316 STAINLESS STEEL POPPET COUPLER/PLUG			
	Max. Working		Burst		Max. Working		Burst		Max. Working		Burst		Max. Working		Burst	
	PSI	Bar	PSI	Bar	PSI	Bar	PSI	Bar	PSI	Bar	PSI	Bar	PSI	Bar	PSI	Bar
1/4"	10,000	700	34,300	2,350	-	-	-	-	-	-	-	-	-	-	-	-
3/8"	10,000	700	30,000	2,050	10,000	700	30,900	2,100	10,000	700	36,800	2,500	10,000	700	36,500	2,500

### Technical Specifications:

BODY SIZE	INTERCHANGE STANDARDS				FUNCTIONAL PARAMETERS				
	U.S. MILITARY	U.S. GOVERNMENT	INTERNATIONAL STANDARDS	ANSI/NFPA STANDARDS	LOCKING BALL QUANTITY	AIR INCLUSION	FLUID LOSS	VACUUM INCH HG	FLOW ΔP = 60 PSI L/MIN
1/4"	-	-	ISO14540	-	Ball	0.97	0.56	N/R	11
3/8"	-	-	ISO14540	-	Ball	2.04	0.98	N/R	15
3/8"	-	-	ISO14540	-	Poppet	1.56	0.77	N/R	23

# Quick Release Couplings

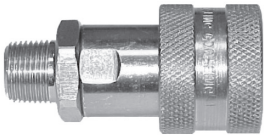

(Male Thread)

## T-SERIES INTERCHANGE (COUPLER)

PART NO.	BODY SIZE	THREAD SIZE	BODY MATERIAL
2TM2	1/4"	1/4"-18 NPTF	Steel
2TBM2	1/4"	1/4"-19 BSPT	Steel
3TM3	3/8"	3/8"-18 NPTF	Steel
3TM3-SS	3/8"	3/8"-18 NPTF	316 Stainless Steel
3TBM3	3/8"	3/8"-19 BSPT	Steel



(Female Thread)

## T-SERIES INTERCHANGE (COUPLER)

PART NO.	BODY SIZE	THREAD SIZE	BODY MATERIAL
3TF3	3/8"	3/8"-18 NPTF	Steel

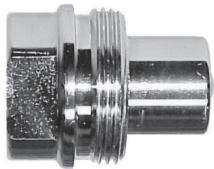

(Female Thread)

## T-SERIES INTERCHANGE (NIPPLE)

PART NO.	BODY SIZE	THREAD SIZE	BODY MATERIAL
T2F2	1/4"	1/4"-18 NPTF	Steel
T2BF2	1/4"	1/4"-19 BSPP	Steel
T3F3	3/8"	3/8"-18 NPTF	Steel
T3F3-SS	3/8"	3/8"-18 NPTF	316 Stainless Steel
T3BF3	3/8"	3/8"-19 BSPP	Steel



(Male Thread)

## T-SERIES HIGH PRESSURE POPPET INTERCHANGE COUPLER

PART NO	BODY SIZE	THREAD SIZE	BODY MATERIAL
3TM3-PV	3/8"	1/2" - 18 NPT	Steel
3TM3-SS-PV	3/8"	1/2" - 18 NPT	316 Stainless Steel

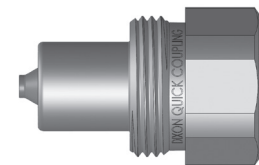

(Female Thread)

## T-SERIES HIGH PRESSURE POPPET INTERCHANGE COUPLER

PART NO	BODY SIZE	THREAD SIZE	BODY MATERIAL
T3F3-PV	3/8"	1/2" - 18 NPT	Steel
T3F3-SS-PV	3/8"	1/2" - 18 NPT	316 Stainless Steel



## T-SERIES INTERCHANGE (COUPLER RIGID DUST PLUG)

PART NO.	BODY SIZE	CAP LANYARD	BODY MATERIAL
2TDP	1/4"	Rubber	Steel
3TDP	3/8"	Rubber	Steel

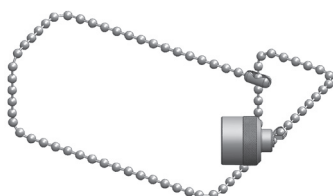

## T-SERIES INTERCHANGE (NIPPLE RIGID DUST CAP)

PART NO.	BODY SIZE	CAP LANYARD	BODY MATERIAL
T2DC	1/4"	SS Bead Chain	Steel
T3DC	3/8"	SS Bead Chain	Steel

## CVV-Series European Screw-Together Interchange

### Interchange Data:

- European Screw-Together Interchange
- Inteva STG-Series, Faster CVV-Series, DNP PVV3, Voswinkel Type-HS

### Materials:

- Machined components are manufactured using solid Steel bar stock.
- Steel retaining rings, and springs maximise service life in rugged environments.
- Steel componentry is plated using ROHS Compliant Trivalent Chrome.



### Seal Components:

- Nitrile (Buna-N) seals are standard, providing a temperature range of -25°C to +125°C (-13°F to +257°F).
- Nipples have a PTFE Anti-Extrusion ring to prevent O-Ring damage during dynamic impulse service.

### Rated Pressure Chart:

CVV-SERIES EUROPEAN SCREW-TOGETHER INTERCHANGE				
BODY SIZE	COUPLER/PLUG COUPLED			
	MAX. WORKING		BURST	
	PSI	Bar	PSI	Bar
1/4"	6,500	450	26,000	1,800
3/8"	6,500	450	26,000	1,800
1/2"	5,800	400	23,200	1,600
3/4"	5,800	400	23,200	1,600
1"	4,400	300	17,600	1,200
1 1/4"	4,400	300	17,600	1,200

### Technical Specifications:

BODY SIZE	INTERCHANGE STANDARDS				FUNCTIONAL PARAMETERS				
	U.S. MILITARY	U.S. GOVERNMENT	INTERNATIONAL STANDARDS	ANSI/NFPA STANDARDS	LOCKING MECHANISM	AIR INCLUSION	FLUID LOSS	VACUUM INCH HG	FLOW $\Delta P = 22$ PSI L/MIN
1/4"	-	-	-	-	Threaded	N/A	N/A	27.4	26
3/8"	-	-	-	-	Threaded	N/A	N/A	27.4	38
1/2"	-	-	-	-	Threaded	N/A	N/A	27.4	56
3/4"	-	-	-	-	Threaded	N/A	N/A	27.4	98
1"	-	-	-	-	Threaded	N/A	N/A	27.4	169
1 1/4"	-	-	-	-	Threaded	N/A	N/A	27.4	263

Note: Threaded sleeves enable easy connection and disconnection while system is under residual pressure only.

# Quick Release Couplings

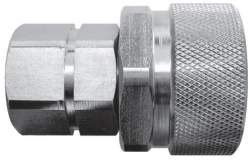

(Female Thread)

## CVV-SERIES EUROPEAN INTERCHANGE COUPLER

PART NO	BODY SIZE	THREAD SIZE	BODY MATERIAL
2CVVF2	1/4"	1/4" - 18 NPTF	Steel
2CVVBF2	1/4"	1/4" - 19 BSPP	Steel
2CVVFM1415	1/4"	M14X1.5	Steel
3CVVF3	3/8"	3/8" - 18 NPTF	Steel
3CVVBF3	3/8"	3/8" - 19 BSPP	Steel
3CVVFM1615	3/8"	M16X1.5	Steel
4CVVF4	1/2"	1/2" - 14 NPTF	Steel
4CVVOF4	1/2"	3/4" - 16 ORB	Steel
4CVVBF4	1/2"	1/2" - 14 BSPP	Steel
4CVVFM1815	1/2"	M18X1.5	Steel
4CVVOF5	1/2"	7/8" - 14ORB	Steel
4CVVFM2215	1/2"	M22X1.5	Steel
6CVVF6	3/4"	3/4" - 14 NPTF	Steel
6CVVBF6	3/4"	3/4" - 14 BSPP	Steel
6CVVFM2215	3/4"	M22X1.5	Steel
8CVVF8	1"	1" - 11 1/2 NPTF	Steel
8CVVBF8	1"	1" - 11 BSPP	Steel
10CVVF10	1 1/4"	1 1/4" - 11 1/2 NPTF	Steel
10CVVBF10	1 1/4"	1 1/4" - 11 BSPP	Steel

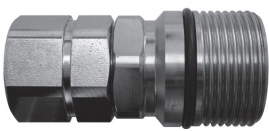

(Female Thread)

## CVV-SERIES EUROPEAN INTERCHANGE NIPPLE

PART NO	BODY SIZE	THREAD SIZE	BODY MATERIAL
CVV2F2	1/4"	1/4" - 18 NPTF	Steel
CVV2BF2	1/4"	1/4" - 19 BSPP	Steel
CVV2FM1415	1/4"	M14X1.5	Steel
CVV3F3	3/8"	3/8" - 18 NPTF	Steel
CVV3BF3	3/8"	3/8" - 19 BSPP	Steel
CVV3FM1615	3/8"	M16X1.5	Steel
CVV4F4	1/2"	1/2" - 14 NPTF	Steel
CVV4OF4	1/2"	3/4" - 16 ORB	Steel
CVV4BF4	1/2"	1/2" - 14 BSPP	Steel
CVV4FM1815	1/2"	M18X1.5	Steel
CVV4OF5	1/2"	7/8" - 14ORB	Steel
CVV4FM2215	1/2"	M22X1.5	Steel
CVV6F6	3/4"	3/4" - 14 NPTF	Steel
CVV6BF6	3/4"	3/4" - 14 BSPP	Steel
CVV6FM2215	3/4"	M22X1.5	Steel
CVV8F8	1"	1" - 11 1/2 NPTF	Steel
CVV8BF8	1"	1" - 11 BSPP	Steel
CVV10F10	1 1/4"	1 1/4" - 11 1/2 NPTF	Steel
CVV10BF10	1 1/4"	1 1/4" - 11 BSPP	Steel



## CVV-SERIES EUROPEAN INTERCHANGE DUST PLUG

PART NO	BODY SIZE	LANYARD	MATERIAL
2CVVDP	1/4"	Plastic	Plastic
3CVVDP	3/8"	Plastic	Plastic
4CVVDP	1/2"	Plastic	Plastic
6CVVDP	3/4"	Plastic	Plastic
8CVVDP	1"	Plastic	Plastic
10CVVDP	1 1/4"	Plastic	Plastic

## CVV-SERIES EUROPEAN INTERCHANGE DUST CAP

PART NO	BODY SIZE	LANYARD	MATERIAL
CVV2DC	1/4"	Plastic	Plastic
CVV3DC	3/8"	Plastic	Plastic
CVV4DC	1/2"	Plastic	Plastic
CVV6DC	3/4"	Plastic	Plastic
CVV8DC	1"	Plastic	Plastic
CVV10DC	1 1/4"	Plastic	Plastic

## E-Series Straight-Through Interchange

### Interchange Data:

- Straight-Through Pressure-Wash Interchange
- Parker ST-Series, Foster FST-Series, Tomco Series-ST, Hansen ST-Series

### Materials:

- Machined components are manufactured using solid Steel, Brass, or 303 Stainless Steel bar stock.
- Stainless Steel balls, retaining rings, and springs maximise corrosion resistance and extend service life.
- Steel componentry is plated using ROHS Compliant Trivalent Chrome.
- 1¼" to 2" Brass couplers have Steel sleeves as standard to maximise service life, hardened to resist deformation.
- Steel nipples are hardened to provide heavy duty performance.

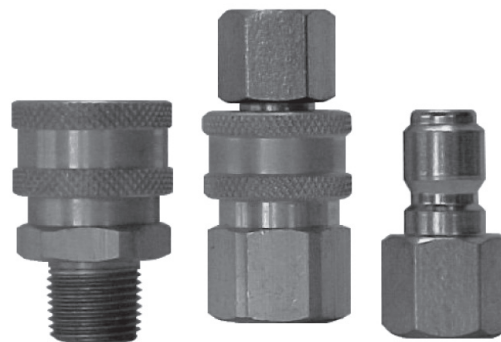

### Seal Components:

- Nitrile (Buna-N) seals are standard, providing a temperature range of -40°C to +121°C (-40°F to +250°F)

### Rated Pressure Chart:

E-SERIES STRAIGHT-THROUGH INTERCHANGE (CONNECTED)																
BODY SIZE	BRASS COUPLER/STEEL PLUG				BRASS COUPLER/PLUG				BRASS COUPLER/303 STAINLESS STEEL PLUG				303 STAINLESS STEEL COUPLER/PLUG			
	Max. Working		Burst		Max. Working		Burst		Max. Working		Burst		Max. Working		Burst	
	PSI	Bar	PSI	Bar	PSI	Bar	PSI	Bar	PSI	Bar	PSI	Bar	PSI	Bar	PSI	Bar
1/8"	4,000	276	16,100	1110	2,800	193	11,800	814	4,000	276	20,000	1379	5,000	345	29,900	2062
1/4"	5,500	379	22,000	1517	3,800	262	15,300	1055	5,500	379	23,500	1621	7,500	517	33,800	2331
3/8"	4,500	310	18,300	1262	3,000	207	14,100	972	4,500	310	21,200	1462	7,500	517	34,400	2372
1/2"	3,500	241	13,900	960	2,400	166	9,700	669	3,500	241	14,000	966	3,500	241	14,000	966
3/4"	3,100	207	12,900	870	2,000	138	8,700	600	2,500	172	12,500	862	3,000	207	19,400	1338
1"	2,500	172	10,100	697	1,600	110	6,700	462	2,000	138	8,800	607	2,000	138	9,100	628
1 1/4"	2,500	172	12,600	870	1,800	124	7,500	517	1,800	124	7,500	517	2,000	138	10,000	690
1 1/2"	2,500	172	10,000	690	1800	124	7,500	517	1,800	124	7,500	517	2,000	138	12,000	828
2"	2,500	172	10,000	690	1800	124	7,500	517	1,800	124	5,500	379	2,000	138	9,000	621



### Technical Specifications:

BODY SIZE	INTERCHANGE STANDARDS				FUNCTIONAL PARAMETERS				
	U.S. MILITARY	U.S. GOVERNMENT	INTERNATIONAL STANDARDS	ANSI/NFPA STANDARDS	LOCKING BALL QUANTITY	AIR INCLUSION	FLUID LOSS	VACUUM INCH HG	FLOW ΔP = 15 PSI L/MIN
1/8"	-	-	-	-	6	N/A	N/A	N/R	11
1/4"	-	-	-	-	6	N/A	N/A	N/R	23
3/8"	-	-	-	-	8	N/A	N/A	N/R	53
1/2"	-	-	-	-	8	N/A	N/A	N/R	90
3/4"	-	-	-	-	8	N/A	N/A	N/R	218
1"	-	-	-	-	8	N/A	N/A	N/R	376
1 1/4"	-	-	-	-	8	N/A	N/A	N/R	564
1 1/2"	-	-	-	-	8	N/A	N/A	N/R	940
2"	-	-	-	-	8	N/A	N/A	N/R	1316



# Quick Release Couplings

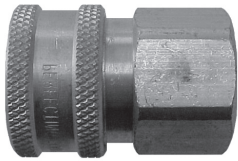

(Female Thread)

## E-SERIES STRAIGHT-THROUGH INTERCHANGE (COUPLER)

PART NO.	BODY SIZE	THREAD SIZE	BODY MATERIAL
1EF1-B	1/8"	1/8"-27 NPTF	Brass
1EF1-S	1/8"	1/8"-27 NPTF	303 Stainless Steel
2EF2-B	1/4"	1/4"-18 NPTF	Brass
2EBF2-B	1/4"	1/4"-19 BSPP	Brass
2EF2-S	1/4"	1/4"-18 NPTF	303 Stainless Steel
3EF3-B	3/8"	3/8"-18 NPTF	Brass
3EBF3-B	3/8"	3/8"-19 BSPP	Brass
3EF3-S	3/8"	3/8"-18 NPTF	303 Stainless Steel
4EF4-B	1/2"	1/2"-14 NPTF	Brass
4EBF4-B	1/2"	1/2"-14 BSPP	Brass
4EF4-S	1/2"	1/2"-14 NPTF	303 Stainless Steel
6EF6-B	3/4"	3/4"-14 NPTF	Brass
6EBF6-B	3/4"	3/4"-14 BSPP	Brass
6EF6-S	3/4"	3/4"-14 NPTF	303 Stainless Steel
8EF8-B	1"	1"-11 1/2 NPTF	Brass
8EBF8-B	1"	1"-11 BSPP	Brass
8EF8-S	1"	1"-11 1/2 NPTF	303 Stainless Steel
10EF10-B	1 1/4"	1 1/4"-11 1/2 NPTF	Brass
10EF10-S	1 1/4"	1 1/4"-11 1/2 NPTF	303 Stainless Steel
12EF12-B	1 1/2"	1 1/2"-11 1/2 NPTF	Brass
12EF12-S	1 1/2"	1 1/2"-11 1/2 NPTF	303 Stainless Steel
16EF16-B	2"	2"-11 1/2 NPTF	Brass
16EF16-S	2"	2"-11 1/2 NPTF	303 Stainless Steel

## E-SERIES STRAIGHT-THROUGH INTERCHANGE (NIPPLE)

PART NO.	BODY SIZE	THREAD SIZE	BODY MATERIAL
E1F1	1/8"	1/8"-27 NPTF	Steel
E1F1-B	1/8"	1/8"-27 NPTF	Brass
E1F1-S	1/8"	1/8"-27 NPTF	303 Stainless Steel
E2F2	1/4"	1/4"-18 NPTF	Steel
E2F2-B	1/4"	1/4"-18 NPTF	Brass
E2BF2-B	1/4"	1/4"-19 BSPP	Brass
E2F2-S	1/4"	1/4"-18 NPTF	303 Stainless Steel
E3F3	3/8"	3/8"-18 NPTF	Steel
E3F3-B	3/8"	3/8"-18 NPTF	Brass
E3BF3-B	3/8"	3/8"-19 BSPP	Brass
E3F3-S	3/8"	3/8"-18 NPTF	303 Stainless Steel
E4F4	1/2"	1/2"-14 NPTF	Steel
E4F4-B	1/2"	1/2"-14 NPTF	Brass
E4BF4-B	1/2"	1/2"-14 BSPP	Brass
E4F4-S	1/2"	1/2"-14 NPTF	303 Stainless Steel
E6F6	3/4"	3/4"-14 NPTF	Steel
E6F6-B	3/4"	3/4"-14 NPTF	Brass
E6BF6-B	3/4"	3/4"-14 BSPP	Brass
E6F6-S	3/4"	3/4"-14 NPTF	303 Stainless Steel
E8F8	1"	1"-11 1/2 NPTF	Steel
E8F8-B	1"	1"-11 1/2 NPTF	Brass
E8BF8-B	1"	1"-11 BSPP	Brass
E8F8-S	1"	1"-11 1/2 NPTF	303 Stainless Steel
E10F10	1 1/4"	1 1/4"-11 1/2 NPTF	Steel
E10F10-B	1 1/4"	1 1/4"-11 1/2 NPTF	Brass
E10F10-S	1 1/2"	1 1/4"-11 1/2 NPTF	303 Stainless Steel
E12F12	1 1/2"	1 1/2"-11 1/2 NPTF	Steel
E12F12-B	1 1/2"	1 1/2"-11 1/2 NPTF	Brass
E12F12-S	1 1/2"	1 1/2"-11 1/2 NPTF	303 Stainless Steel
E16F16	2"	2"-11 1/2 NPTF	Steel
E16F16-B	2"	2"-11 1/2 NPTF	Brass
E16F16-S	2"	2"-11 1/2 NPTF	303 Stainless Steel

R

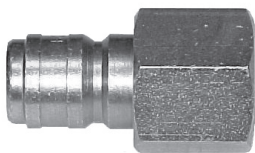

(Female Thread)

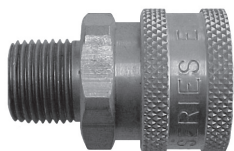

(Male Thread)

## E-SERIES STRAIGHT-THROUGH INTERCHANGE (COUPLER)

PART NO.	BODY SIZE	THREAD SIZE	BODY MATERIAL
1EM1-B	1/8"	1/8"-27 NPTF	Brass
1EM1-S	1/8"	1/8"-27 NPTF	303 Stainless Steel
2EM2-B	1/4"	1/4"-18 NPTF	Brass
2EM2-S	1/4"	1/4"-18 NPTF	303 Stainless Steel
3EM3-B	3/8"	3/8"-18 NPTF	Brass
3EM3-S	3/8"	3/8"-18 NPTF	303 Stainless Steel
4EM4-B	1/2"	1/2"-14 NPTF	Brass
4EM4-S	1/2"	1/2"-14 NPTF	303 Stainless Steel
6EM6-B	3/4"	3/4"-14 NPTF	Brass
6EM6-S	3/4"	3/4"-14 NPTF	303 Stainless Steel
8EM8-B	1"	1"-11 1/2 NPTF	Brass
8EM8-S	1"	1"-11 1/2 NPTF	303 Stainless Steel

## E-SERIES STRAIGHT-THROUGH INTERCHANGE (NIPPLE)

PART NO.	BODY SIZE	THREAD SIZE	BODY MATERIAL
E1M1	1/8"	1/8"-27 NPTF	Steel
E1M1-B	1/8"	1/8"-27 NPTF	Brass
E1M1-S	1/8"	1/8"-27 NPTF	303 Stainless Steel
E2M2	1/4"	1/4"-18 NPTF	Steel
E2M2-B	1/4"	1/4"-18 NPTF	Brass
E2M2-S	1/4"	1/4"-18 NPTF	303 Stainless Steel
E3M3	3/8"	3/8"-18 NPTF	Steel
E3M3-B	3/8"	3/8"-18 NPTF	Brass
E3M3-S	3/8"	3/8"-18 NPTF	303 Stainless Steel
E4M4	1/2"	1/2"-14 NPTF	Steel
E4M4-B	1/2"	1/2"-14 NPTF	Brass
E4M4-S	1/2"	1/2"-14 NPTF	303 Stainless Steel
E6M6	3/4"	3/4"-14 NPTF	Steel
E6M6-B	3/4"	3/4"-14 NPTF	Brass
E6M6-S	3/4"	3/4"-14 NPTF	303 Stainless Steel
E8M8	1"	1"-11 1/2 NPTF	Steel
E8M8-B	1"	1"-11 1/2 NPTF	Brass
E8M8-S	1"	1"-11 1/2 NPTF	303 Stainless Steel
E10M10	1 1/4"	1 1/4"-11 1/2 NPTF	Steel
E10M10-B	1 1/4"	1 1/4"-11 1/2 NPTF	Brass
E12M12	1 1/2"	1 1/2"-11 1/2 NPTF	Steel
E12M12-B	1 1/2"	1 1/2"-11 1/2 NPTF	Brass
E16M16	2"	2"-11 1/2 NPTF	Steel
E16M16-B	2"	2"-11 1/2 NPTF	Brass



(Male Thread)

## E-SERIES STRAIGHT-THROUGH INTERCHANGE (COUPLER)

PART NO.	BODY SIZE	BARB CONFIGURATION	BODY MATERIAL
2ES2-B	1/4"	1/4" Hose Barb	Brass
3ES3-B	3/8"	3/8" Hose Barb	Brass
4ES4-B	1/2"	1/2" Hose Barb	Brass
6ES6-B	3/4"	3/4" Hose Barb	Brass
8ES8-B	1"	1" Hose Barb	Brass

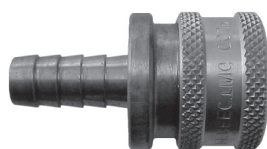

(Standard Hose Barb)

## E-SERIES STRAIGHT-THROUGH INTERCHANGE (NIPPLE)

PART NO.	BODY SIZE	BARB CONFIGURATION	BODY MATERIAL
E2S2	1/4"	1/4" Hose Barb	Steel
E2S2-B	1/4"	1/4" Hose Barb	Brass
E3S3	3/8"	3/8" Hose Barb	Steel
E3S3-B	3/8"	3/8" Hose Barb	Brass
E4S4	1/2"	1/2" Hose Barb	Steel
E4S4-B	1/2"	1/2" Hose Barb	Brass
E6S6	3/4"	3/4" Hose Barb	Steel
E6S6-B	3/4"	3/4" Hose Barb	Brass
E8S8	1"	1" Hose Barb	Steel
E8S8-B	1"	1" Hose Barb	Brass



(Standard Hose Barb)

# Quick Release Couplings

## EA-Series Water-Blast Interchange

### Interchange Data:

- Water-Blast Interchange
- Parker Series-WB, Aeroquip FD69, Snap-Tite 56-Series

### Materials:

- Machined components are manufactured using solid high strength Steel bar stock
- Stainless Steel springs and retaining rings maximise corrosion resistance and extend service life
- Latches are manufactured from high-strength Steel and plated with electroless nickel
- Steel nipples are machined from solid high strength Steel bar stock and hardened
- Machined Steel componentry is plated using ROHS Compliant Trivalent Chrome



### Seal Components:

- Nitrile (Buna-N) seals are standard, providing a temperature range of -40°C to +121°C (-40°F to +250°F)
- Couplers have a PTFE Anti-Extrusion ring, providing resistance to O-Ring dynamic impulse pressure damage

### Rated Pressure Chart:

EA-SERIES WATER-BLAST INTERCHANGE (CONNECTED)				
BODY SIZE	COUPLER/PLUG COUPLED			
	MAX. WORKING		BURST	
	PSI	Bar	PSI	Bar
1/2"	10,000	700	30,000	2,100

### Technical Specifications:

BODY SIZE	INTERCHANGE STANDARDS				FUNCTIONAL PARAMETERS				
	U.S. MILITARY	U.S. GOVERNMENT	INTERNATIONAL STANDARDS	ANSI/NFPA STANDARDS	LOCKING BALL QUANTITY	AIR INCLUSION	FLUID LOSS	VACUUM INCH HG	FLOW ΔP = 40 PSI L/MIN
1/2"	-	-	-	-	Maxi-Latch	N/A	N/A	N/R	150

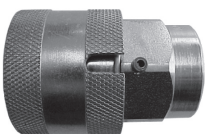

(Female Thread)

### EA-SERIES WATER-BLAST INTERCHANGE (COUPLER)

PART NO.	BODY SIZE	THREAD SIZE	BODY MATERIAL
4EAF3	1/2"	3/8"-18 NPTF	Steel
4EAF4	1/2"	1/2"-14 NPTF	Steel

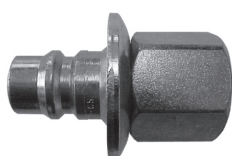

(Female Thread)

### EA-SERIES WATER-BLAST INTERCHANGE (NIPPLE)

PART NO.	BODY SIZE	THREAD SIZE	BODY MATERIAL
EA4F3	1/2"	3/8"-18 NPTF	Steel
EA4F4	1/2"	1/2"-14 NPTF	Steel



## DF-Series Industrial Interchange

### Interchange Data:

- Parker 20-Series Manual Interchange (F-Series)
- Parker 30-Series Automatic Interchange (D-Series)
- Foster 3, 4, 5, and 6 Series
- Hansen 1000, 400, 500 (F-Series)
- Hansen 3000, 4000, 5000, 6000 (D-Series)



### Materials:

- Machined components are manufactured using solid Steel, Brass, or 303 Stainless Steel bar stock
- Stainless Steel balls, retaining rings, and springs maximise corrosion resistance and extend service life
- Steel componentry is plated using ROHS Compliant Trivalent Chrome
- Automatic couplers constructed of Brass with Steel tubular valve as standard (3/8" to 3/4" couplers have Steel prong valves)

- 1/4" manual couplers constructed of Brass with Steel sleeve and Steel tubular valve as standard
- 3/8" and 1/2" manual couplers constructed of Steel as standard with Steel tubular valve.

### Seal Components:

- Nitrile (Buna-N) seals are standard, providing a temperature range of -40°C to +121°C (-40°F to +250°F)

### Rated Pressure Chart:

D-SERIES AUTOMATIC INDUSTRIAL INTERCHANGE (CONNECTED)																
BODY SIZE	BRASS COUPLER/STEEL PLUG				BRASS COUPLER/PLUG				STEEL COUPLER/PLUG				303 STAINLESS COUPLER/PLUG			
	Max. Working		Burst		Max. Working		Burst		Max. Working		Burst		Max. Working		Burst	
	PSI	Bar	PSI	Bar	PSI	Bar	PSI	Bar	PSI	Bar	PSI	Bar	PSI	Bar	PSI	Bar
1/4"	500	35	16,000	1,100	300	20	16,000	1,100	-	-	-	-	500	35	26,000	1,795
3/8"	500	35	15,500	1,070	300	20	14,500	1,000	-	-	-	-	500	35	25,500	1,760
1/2"	500	35	14,000	965	300	20	10,500	725	-	-	-	-	500	35	20,500	1,415
3/4"	500	35	10,000	670	-	-	-	-	-	-	-	-	-	-	-	-

F-SERIES MANUAL INDUSTRIAL INTERCHANGE (CONNECTED)																
BODY SIZE	BRASS COUPLER/STEEL PLUG				BRASS COUPLER/PLUG				STEEL COUPLER/PLUG				303 STAINLESS COUPLER/PLUG			
	Max. Working		Burst		Max. Working		Burst		Max. Working		Burst		Max. Working		Burst	
	PSI	Bar	PSI	Bar	PSI	Bar	PSI	Bar	PSI	Bar	PSI	Bar	PSI	Bar	PSI	Bar
1/4"	500	35	9,000	620	300	20	8,500	586	500	35	6,500	448	500	35	11,500	795
3/8"	500	35	11,500	790	300	20	10,000	690	500	35	19,500	1,345	500	35	20,500	1,415
1/2"	-	-	-	-	-	-	-	-	500	35	15,500	1,070	500	35	15,000	1,035

### Technical Specifications:

BODY SIZE	INTERCHANGE STANDARDS				FUNCTIONAL PARAMETERS				
	U.S. MILITARY	U.S. GOVERNMENT	INTERNATIONAL STANDARDS	ANSI/NFPA STANDARDS	LOCKING BALL QUANTITY	AIR INCLUSION	FLUID LOSS	VACUUM INCH HG	FLOW ΔP = 15 PSI CFM
1/4"	MIL-C-4109F	A-A-59439	ISO6150B	T3.20.14-1990	6	N/A	N/A	N/R	27
3/8"	-	-	ISO6150B	T3.20.14-1990	6	N/A	N/A	N/R	45
1/2"	MIL-C-4109F	A-A-59439	ISO6150B	T3.20.14-1990	6	N/A	N/A	N/R	91
3/4"	-	-	-	T3.20.14-1990	9	N/A	N/A	N/R	200

# Quick Release Couplings



(Reusable Barb)

## D-SERIES INDUSTRIAL INTERCHANGE (AUTOMATIC SAFETY COUPLER)

PART NO.	BODY SIZE	BARB CONFIGURATION	BODY MATERIAL
2DE2-B	1/4"	1/4" ID X 1/2" OD	Brass
2DH2-B	1/4"	1/4" ID X 5/8" OD	Brass
2DH2-S	1/4"	1/4" ID X 5/8" OD	303 Stainless Steel
2DK3-B	1/4"	3/8" ID X 11/16" OD	Brass
2DL3-B	1/4"	3/8" ID X 3/4" OD	Brass

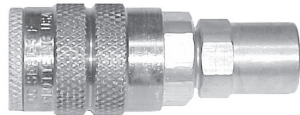

(Reusable Barb)

## F-SERIES INDUSTRIAL INTERCHANGE (MANUAL COUPLER)

PART NO.	BODY SIZE	BARB CONFIGURATION	BODY MATERIAL
2FE2-B	1/4"	1/4" ID X 1/2" OD	Brass
2FH2-B	1/4"	1/4" ID X 5/8" OD	Brass
2FH2-S	1/4"	1/4" ID X 5/8" OD	303 Stainless Steel
2FK3-B	1/4"	3/8" ID X 11/16" OD	Brass
2FL3-B	1/4"	3/8" ID X 3/4" OD	Brass

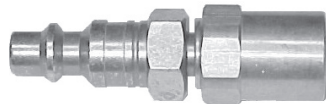

(Reusable Barb)

## DF-SERIES INDUSTRIAL INTERCHANGE (NIPPLE)

PART NO.	BODY SIZE	BARB CONFIGURATION	BODY MATERIAL
D2E2	1/4"	1/4" ID X 1/2" OD	Brass
D2H2	1/4"	1/4" ID X 5/8" OD	Brass
D2H2-S	1/4"	1/4" ID X 5/8" OD	303 Stainless Steel
D2K3	1/4"	3/8" ID X 11/16" OD	Brass
D2L3	1/4"	3/8" ID X 3/4" OD	Brass

## D-SERIES INDUSTRIAL INTERCHANGE (AUTOMATIC SAFETY COUPLER)

PART NO.	BODY SIZE	THREAD SIZE	BODY MATERIAL
2DF1-B	1/4"	1/8"-27 NPTF	Brass
2DF2-B	1/4"	1/4"-18 NPTF	Brass
2DF2-S	1/4"	1/4"-18 NPTF	303 Stainless Steel
2DBF2-B	1/4"	1/4"-19 BSPP	Brass
2DF3-B	1/4"	3/8"-18 NPTF	Brass
2DBF3-B	1/4"	3/8"-19 BSPP	Brass
3DF2-B	3/8"	1/4"-18 NPTF	Brass
3DF3-B	3/8"	3/8"-18 NPTF	Brass
3DF3-S	3/8"	3/8"-18 NPTF	303 Stainless Steel
3DBF3-B	3/8"	3/8"-19 BSPP	Brass
3DF4-B	3/8"	1/2"-14 NPTF	Brass
4DF3-B	1/2"	3/8"-18 NPTF	Brass
4DF4-B	1/2"	1/2"-14 NPTF	Brass
4DF4-S	1/2"	1/2"-14 NPTF	303 Stainless Steel
4DBF4-B	1/2"	1/2"-14 BSPP	Brass
4DF6-B	1/2"	3/4"-14 NPTF	Brass
6DF4-B	3/4"	1/2"-14 NPTF	Brass
6DF6-B	3/4"	3/4"-14 NPTF	Brass
6DF8-B	3/4"	1"-11 1/2 NPTF	Brass



(Female Thread)

T

## F-SERIES INDUSTRIAL INTERCHANGE (MANUAL COUPLER)

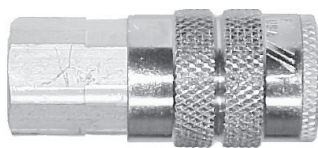

(Female Thread)

PART NO.	BODY SIZE	THREAD SIZE	BODY MATERIAL
2FF1-B	1/4"	1/8"-27 NPTF	Brass
2FBF1-B	1/4"	1/8"-28 BSPP	Brass
2FF2-B	1/4"	1/4"-18 NPTF	Brass
2FF2	1/4"	1/4"-18 NPTF	Steel
2FF2-S	1/4"	1/4"-18 NPTF	303 Stainless Steel
2FBF2-B	1/4"	1/4"-19 BSPP	Brass
2FF3-B	1/4"	3/8"-18 NPTF	Brass
2FBF3-B	1/4"	3/8"-19 BSPP	Brass
3FF2	3/8"	1/4"-18 NPTF	Steel
3FF3	3/8"	3/8"-18 NPTF	Steel
3FF3-S	3/8"	3/8"-18 NPTF	303 Stainless Steel
3FBF3	3/8"	3/8"-19 BSPP	Steel
3FF4	3/8"	1/2"-14 NPTF	Steel
4FF3	1/2"	3/8"-18 NPTF	Steel
4FF4	1/2"	1/2"-14 NPTF	Steel
4FF4-S	1/2"	1/2"-14 NPTF	303 Stainless Steel
4FBF4	1/2"	1/2"-14 BSPP	Steel
4FF6	1/2"	3/4"-14 NPTF	Steel

## DF-SERIES INDUSTRIAL INTERCHANGE (NIPPLE)



(Female Thread)

PART NO.	BODY SIZE	THREAD SIZE	BODY MATERIAL
D2F1	1/4"	1/8"-27 NPTF	Steel
D2F2	1/4"	1/4"-18 NPTF	Steel
D2F2-B	1/4"	1/4"-18 NPTF	Brass
D2F2-S	1/4"	1/4"-18 NPTF	303 Stainless Steel
D2BF2	1/4"	1/4"-19 BSPP	Steel
D2F3	1/4"	3/8"-18 NPTF	Steel
D2F3-B	1/4"	3/8"-18 NPTF	Brass
D2BF3	1/4"	3/8" BSPPT	Steel
D3F2	3/8"	1/4"-18 NPTF	Steel
D3F3	3/8"	3/8"-18 NPTF	Steel
D3F3-B	3/8"	3/8"-18 NPTF	Brass
D3F3-S	3/8"	3/8"-18 NPTF	303 Stainless Steel
D3BF3	3/8"	3/8"-19 BSPP	Steel
D3F4	3/8"	1/2"-14 NPTF	Steel
D4F3	1/2"	3/8"-18 NPTF	Steel
D4F4	1/2"	1/2"-14 NPTF	Steel
D4F4-B	1/2"	1/2"-14 NPTF	Brass
D4F4-S	1/2"	1/2"-14 NPTF	303 Stainless Steel
D4BF4	1/2"	1/2"-14 BSPP	Steel
D4F6	1/2"	3/4"-14 NPTF	Steel
D6F4	3/4"	1/2"-14 NPTF	Steel
D6F6	3/4"	3/4"-14 NPTF	Steel
D6F8	3/4"	1"-11 1/2 NPTF	Steel

T

# Quick Release Couplings

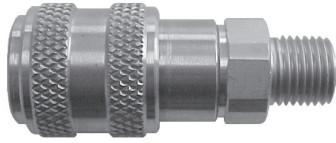

(Male Thread)

## D-SERIES INDUSTRIAL INTERCHANGE (AUTOMATIC SAFETY COUPLER)

PART NO.	BODY SIZE	THREAD SIZE	BODY MATERIAL
2DM1-B	1/4"	1/8"-27 NPTF	Brass
2DM2-B	1/4"	1/4"-18 NPTF	Brass
2DM2-S	1/4"	1/4"-18 NPTF	303 Stainless Steel
2DBM2-B	1/4"	1/4"-19 BSPT	Brass
2DM3-B	1/4"	3/8"-18 NPTF	Brass
2DBM3-B	1/4"	3/8"-19 BSPT	Brass
3DM2-B	3/8"	1/4"-18 NPTF	Brass
3DM3-B	3/8"	3/8"-18 NPTF	Brass
3DM3-S	3/8"	3/8"-18 NPTF	303 Stainless Steel
3DBM3-B	3/8"	3/8"-19 BSPT	Brass
3DM4-B	3/8"	1/2"-14 NPTF	Brass
4DM3-B	1/2"	3/8"-18 NPTF	Brass
4DM4-B	1/2"	1/2"-14 NPTF	Brass
4DM4-S	1/2"	1/2"-14 NPTF	303 Stainless Steel
4DBM4-B	1/2"	1/2"-14 BSPT	Brass
4DM6-B	1/2"	3/4"-14 NPTF	Brass
6DM4-B	3/4"	1/2"-14 NPTF	Brass
6DM6-B	3/4"	3/4"-14 NPTF	Brass
6DM8-B	3/4"	1"-11 1/2 NPTF	Brass

## F-SERIES INDUSTRIAL INTERCHANGE (MANUAL COUPLER)

PART NO.	BODY SIZE	THREAD SIZE	BODY MATERIAL
2FM1-B	1/4"	1/8"-27 NPTF	Brass
2FM1-S	1/4"	1/8"-27 NPTF	303 Stainless Steel
2FM2-B	1/4"	1/4"-18 NPTF	Brass
2FM2	1/4"	1/4"-18 NPTF	Brass
2FM2-S	1/4"	1/4"-18 NPTF	303 Stainless Steel
2FBM2-B	1/4"	1/4"-19 BSPT	Brass
2FM3-B	1/4"	3/8"-18 NPTF	Brass
2FBM3-B	1/4"	3/8"-19 BSPT	Brass
3FM2	3/8"	1/4"-18 NPTF	Steel
3FM3	3/8"	3/8"-18 NPTF	Steel
3FM3-S	3/8"	3/8"-18 NPTF	303 Stainless Steel
3FBM3	3/8"	3/8"-19 BSPT	Steel
3FM4	3/8"	1/2"-14 NPTF	Steel
4FM3	1/2"	3/8"-18 NPTF	Steel
4FM4	1/2"	1/2"-14 NPTF	Steel
4FM4-S	1/2"	1/2"-14 NPTF	303 Stainless Steel
4FBM4	1/2"	1/2"-14 BSPT	Steel
4FM6	1/2"	3/4"-14 NPTF	Steel

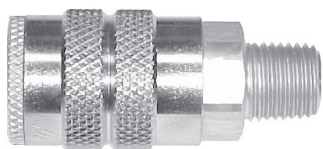

(Male Thread)

## DF-SERIES INDUSTRIAL INTERCHANGE (NIPPLE)



(Male Thread)

PART NO.	BODY SIZE	THREAD SIZE	BODY MATERIAL
D2M1	1/4"	1/8"-27 NPTF	Steel
D2M1-B	1/4"	1/8"-27 NPTF	Steel
D2M1-S	1/4"	1/8"-27 NPTF	303 Stainless Steel
D2M2	1/4"	1/4"-18 NPTF	Steel
D2M2-B	1/4"	1/4"-18 NPTF	Brass
D2M2-S	1/4"	1/4"-18 NPTF	303 Stainless Steel
D2BM2	1/4"	1/4"-19 BSPT	Steel
D2M3	1/4"	3/8"-18 NPTF	Steel
D2M3-B	1/4"	3/8"-18 NPTF	Brass
D2BM3	1/4"	3/8"-19 BSPT	Steel
D3M2	3/8"	1/4"-18 NPTF	Steel
D3M3	3/8"	3/8"-18 NPTF	Steel
D3M3-B	3/8"	3/8"-18 NPTF	Brass
D3M3-S	3/8"	3/8"-18 NPTF	303 Stainless Steel
D3BM3	3/8"	3/8"-19 BSPT	Steel
D3M4	3/8"	1/2"-14 NPTF	Steel
D4M2	1/2"	1/4"-18 NPTF	Steel
D4M3	1/2"	3/8"-18 NPTF	Steel
D4M4	1/2"	1/2"-14 NPTF	Steel
D4M4-B	1/2"	1/2"-14 NPTF	Brass
D4M4-S	1/2"	1/2"-14 NPTF	303 Stainless Steel
D4BM4	1/2"	1/2"-14 BSPT	Steel
D4M6	1/2"	3/4"-14 NPTF	Steel
D6M4	3/4"	1/2"-14 NPTF	Steel
D6M6	3/4"	3/4"-14 NPTF	Steel
D6M8	3/4"	1"-11 1/2 NPTF	Steel

## D-SERIES INDUSTRIAL INTERCHANGE (AUTOMATIC SAFETY COUPLER)



(Standard and Push-Loc Hose Barb)

PART NO.	BODY SIZE	BARB CONFIGURATION	BODY MATERIAL
2DS2-B	1/4"	1/4" Hose Barb	Brass
2DS2-S	1/4"	1/4" Hose Barb	303 Stainless Steel
2DB2-B	1/4"	1/4" Push-Loc	Brass
2DS2.5-B	1/4"	5/16" Hose Barb	Brass
2DS3-B	1/4"	3/8" Hose Barb	Brass
2DB3-B	1/4"	3/8" Push-Loc	Brass
3DS2-B	3/8"	1/4" Hose Barb	Brass
3DS3-B	3/8"	3/8" Hose Barb	Brass
3DS3-S	3/8"	3/8" Hose Barb	303 Stainless Steel
3DB3-B	3/8"	3/8" Push-Loc	Brass
3DS4-B	3/8"	1/2" Hose Barb	Brass
4DS3-B	1/2"	3/8" Hose Barb	Brass
4DS4-B	1/2"	1/2" Hose Barb	Brass
4DS4-S	1/2"	1/2" Hose Barb	303 Stainless Steel
4DB4-B	1/2"	1/2" Hose Barb	Brass
4DS6-B	1/2"	3/4" Hose Barb	Brass
6DS4-B	3/4"	1/2" Hose Barb	Brass
6DS6-B	3/4"	3/4" Hose Barb	Brass
6DS8-B	3/4"	1" Hose Barb	Brass

T

# Quick Release Couplings

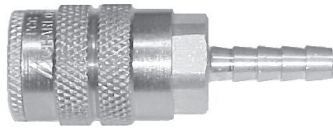

(Standard and Push-Loc Hose Barb)

F-SERIES INDUSTRIAL INTERCHANGE (MANUAL COUPLER)			
PART NO.	BODY SIZE	BARB CONFIGURATION	BODY MATERIAL
2FS2-B	1/4"	1/4" Hose Barb	Brass
2FS2-S	1/4"	1/4" Hose Barb	303 Stainless Steel
2FB2-B	1/4"	1/4" Push-Loc	Brass
2FS2.5-B	1/4"	5/16" Hose Barb	Brass
2FS3-B	1/4"	3/8" Hose Barb	Brass
2FB3-B	1/4"	3/8" Push-Loc	Brass
3FS2	3/8"	1/4" Hose Barb	Steel
3FS3	3/8"	3/8" Hose Barb	Steel
3FS3-S	3/8"	3/8" Hose Barb	303 Stainless Steel
3FB3	3/8"	3/8" Push-Loc	Steel
3FS4	3/8"	1/2" Hose Barb	Steel
4FS3	1/2"	3/8" Hose Barb	Steel
4FS4	1/2"	1/2" Hose Barb	Steel
4FS4-S	1/2"	1/2" Hose Barb	303 Stainless Steel
4FB4	1/2"	1/2" Push-Loc	Steel
4FS6	1/2"	3/4" Hose Barb	Steel

## DF-SERIES INDUSTRIAL INTERCHANGE (NIPPLE)



(Standard and Push-Loc Hose Barb)

PART NO.	BODY SIZE	BARB CONFIGURATION	BODY MATERIAL
D2S2	1/4"	1/4" Hose Barb	Steel
D2S2-B	1/4"	1/4" Hose Barb	Brass
D2S2-S	1/4"	1/4" Hose Barb	303 Stainless Steel
D2B2	1/4"	1/4" Push-Loc	Steel
D2S2.5	1/4"	5/16" Hose Barb	Steel
D2S3	1/4"	3/8" Hose Barb	Steel
D2S3-B	1/4"	3/8" Hose Barb	Brass
D2B3	1/4"	3/8" Push-Loc	Steel
D3S2	3/8"	1/4" Hose Barb	Steel
D3S3	3/8"	3/8" Hose Barb	Steel
D3S3-B	3/8"	3/8" Hose Barb	Brass
D3S3-S	3/8"	3/8" Hose Barb	303 Stainless Steel
D3B3	3/8"	3/8" Push-Loc	Steel
D3S4	3/8"	1/2" Hose Barb	Steel
D4S3	1/2"	3/8" Hose Barb	Steel
D4S4	1/2"	1/2" Hose Barb	Steel
D4S4-B	1/2"	1/2" Hose Barb	Brass
D4S4-S	1/2"	1/2" Hose Barb	303 Stainless Steel
D4B4	1/2"	1/2" Push-Loc	Steel
D4S6	1/2"	3/4" Hose Barb	Steel
D6S4	3/4"	1/2" Hose Barb	Steel
D6S6	3/4"	3/4" Hose Barb	Steel
D6S8	3/4"	1" Hose Barb	Steel

## BR-Series Rectus '21' Interchange

### Interchange Data:

- Rectus 21KA, Tomco Series SC, CEJN Series 223

### Materials:

- Machined components are manufactured using solid Brass bar stock
- Stainless Steel balls, retaining rings, and springs maximise corrosion resistance and extend service life
- Machined components are plated with chrome-over-nickel plating

### Seal Components:

- Nitrile (Buna-N) seals are standard, providing a temperature range of -40°C to +121°C (-40°F to +250°F)



### Rated Pressure Chart:

BR-SERIES RECTUS 21-SERIES INTERCHANGE (CONNECTED)					
BODY SIZE	COUPLER/PLUG COUPLED				
	MAX. WORKING		BURST		
	PSI	Bar	PSI	Bar	
1/8"	300	20	7,000	483	

### Technical Specifications:

BODY SIZE	INTERCHANGE STANDARDS				FUNCTIONAL PARAMETERS				
	U.S. MILITARY	U.S. GOVERNMENT	INTERNATIONAL STANDARDS	ANSI/NFPA STANDARDS	LOCKING BALL QUANTITY	AIR INCLUSION	FLUID LOSS	VACUUM INCH HG	FLOW ΔP = 15 PSI CFM
1/4"	-	-	-	-	6	N/A	N/A	N/R	20

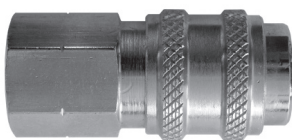

(Female Thread)

### BR-SERIES RECTUS '21' INTERCHANGE (AUTOMATIC COUPLER)

PART NO.	BODY SIZE	THREAD SIZE	BODY MATERIAL
1BRF1-B-7	1/8"	1/8"-27 NPTF	Brass
1BRBF1-B-7	1/8"	1/8" BSPP	Brass
1BRF2-B-7	1/8"	1/4"-18 NPTF	Brass
1BRBF2-B-7	1/8"	1/4" BSPP	Brass

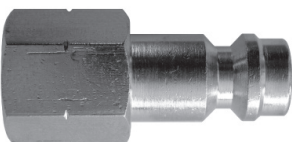

(Female Thread)

### BR-SERIES RECTUS '21' INTERCHANGE (UNVALVED NIPPLE)

PART NO.	BODY SIZE	THREAD SIZE	BODY MATERIAL
BR1F1-B-E-7	1/8"	1/8"-27 NPTF	Brass
BR1BF1-B-E-7	1/8"	1/8" BSPP	Brass
BR1F2-B-E-7	1/8"	1/4"-18 NPTF	Brass
BR1BF2-B-E-7	1/8"	1/4" BSPP	Brass

# Quick Release Couplings

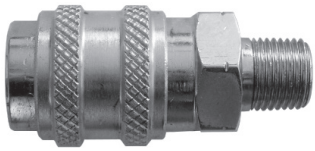

(Male Thread)

## BR-SERIES RECTUS '21' INTERCHANGE (AUTOMATIC COUPLER)

PART NO.	BODY SIZE	THREAD SIZE	BODY MATERIAL
1BRM1-B-7	1/8"	1/8"-27 NPTF	Brass
1BRGM1-B-7	1/8"	1/8" BSPP	Brass
1BRM2-B-7	1/8"	1/4"-18 NPTF	Brass
1BRGM2-B-7	1/8"	1/4" BSPP	Brass



(Male Thread)

## BR-SERIES RECTUS '21' INTERCHANGE (UNVALVED NIPPLE)

PART NO.	BODY SIZE	THREAD SIZE	BODY MATERIAL
BR1M1-B-E-7	1/8"	1/8"-27 NPTF	Brass
BR1GM1-B-E-7	1/8"	1/8" BSPP	Brass
BR1M2-B-E-7	1/8"	1/4"-18 NPTF	Brass
BR1GM2-B-E-7	1/8"	1/4" BSPP	Brass

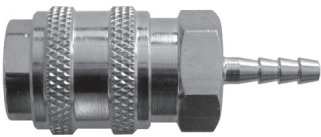

(Standard Hose Barb)

## BR-SERIES RECTUS '21' INTERCHANGE (AUTOMATIC COUPLER)

PART NO.	BODY SIZE	BARB CONFIGURATION	BODY MATERIAL
1BRS1.25-B-7	1/8"	4mm Hose Barb	Brass
1BRS1.88-B-7	1/8"	6mm Hose Barb	Brass
1BRS2.83-B-7	1/8"	9mm Hose Barb	Brass



(Standard Hose Barb)

## BR-SERIES RECTUS '21' INTERCHANGE (UNVALVED NIPPLE)

PART NO.	BODY SIZE	BARB CONFIGURATION	BODY MATERIAL
BR1S1.25-B-E-7	1/8"	4mm Hose Barb	Brass
BR1S1.88-B-E-7	1/8"	6mm Hose Barb	Brass
BR1S2.83-B-E-7	1/8"	9mm Hose Barb	Brass

U



## J-Series Truflate Automotive Interchange

### Interchange Data:

- Truflate Automotive interchange style
- Parker 10-Series
- Rectus 55KM
- Tomco A2100/PT400

### Materials:

- Machined components are manufactured using solid Steel or Brass bar stock
- Stainless Steel balls, retaining rings, and springs maximise corrosion resistance and extend service life
- Steel componentry is plated using ROHS Compliant Trivalent Chrome
- 1/4" couplers constructed of Brass with Steel sleeve and Steel tubular valve as standard
- 3/8" and 1/2" couplers constructed of Steel as standard with Steel tubular valves



### Seal Components:

- Nitrile (Buna-N) seals are standard providing a temperature range of -40°C to +121°C (-40°F to +250°F)

### Rated Pressure Chart:

J-SERIES TRUFLATE INTERCHANGE (CONNECTED)																	
BODY SIZE	BRASS COUPLER/STEEL PLUG				BRASS COUPLER/PLUG				STEEL COUPLER/PLUG				303 STAINLESS COUPLER/PLUG				
	Max. Working		Burst		Max. Working		Burst		Max. Working		Burst		Max. Working		Burst		
	PSI	Bar	PSI	Bar	PSI	Bar	PSI	Bar	PSI	Bar	PSI	Bar	PSI	Bar	PSI	Bar	
1/4"	500	35	11,500	793	300	20	10,500	724	-	-	-	-	-	-	-	-	-
3/8"	-	-	-	-	-	-	-	-	500	35	18,000	1,241	-	-	-	-	-
1/2"	-	-	-	-	-	-	-	-	500	35	10,000	690	-	-	-	-	-

### Technical Specifications:

BODY SIZE	INTERCHANGE STANDARDS				FUNCTIONAL PARAMETERS				
	U.S. MILITARY	U.S. GOVERNMENT	INTERNATIONAL STANDARDS	ANSI/NFPA STANDARDS	LOCKING BALL QUANTITY	AIR INCLUSION	FLUID LOSS	VACUUM INCH HG	FLOW ΔP = 15 PSI CFM
1/4"	-	-	-	-	6	N/A	N/A	N/R	26
3/8"	-	-	-	-	6	N/A	N/A	N/R	58
1/2"	-	-	-	-	6	N/A	N/A	N/A	91

Operating pressure for couplings utilizing hose barb end connections may be dramatically reduced to that of the hose rating and/or hose end connection combination. Consult hose manufacturer's catalogue for hose end connection ratings. In doubt, test under controlled conditions for suitability to application. Dixon Quick Coupling cannot assume liability for misapplication of production resulting in equipment down-time, lost production, and/or personal injury including death.

# Quick Release Couplings

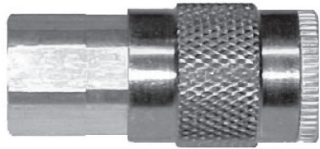

(Female Thread)

J-SERIES TRUFLATE AUTOMOTIVE INTERCHANGE (MANUAL COUPLER)			
PART NO.	BODY SIZE	THREAD SIZE	BODY MATERIAL
2JF1-B	1/4"	1/8"-27 NPTF	Brass
2JF2-B	1/4"	1/4"-18 NPTF	Brass
2JBF2-B	1/4"	1/4"-19 BSPP	Brass
2JF3-B	1/4"	3/8"-18 NPTF	Brass
3JF2	3/8"	1/4"-18 NPTF	Steel
3JF3	3/8"	3/8"-18 NPTF	Steel
3JBF3	3/8"	3/8"-19 BSPP	Steel
3JF4	3/8"	1/2"-14 NPTF	Steel
4FF3	1/2"	3/8"-18 NPTF	Steel
4FF4	1/2"	1/2"-14 NPTF	Steel
4FBF4	1/2"	1/2"-14 BSPP	Steel
4FF6	1/2"	3/4"-14 NPTF	Steel



(Female Thread)

J-SERIES TRUFLATE AUTOMOTIVE INTERCHANGE (NIPPLE)			
PART NO.	BODY SIZE	THREAD SIZE	BODY MATERIAL
J2F1	1/4"	1/8"-27 NPTF	Steel
J2F2	1/4"	1/4"-18 NPTF	Steel
J2BF2	1/4"	1/4"-18 NPTF	Brass
J2BF2	1/4"	1/4"-19 BSPP	Steel
J2F3	1/4"	3/8"-18 NPTF	Steel
J3F2	3/8"	1/4"-18 NPTF	Steel
J3F3	3/8"	3/8"-18 NPTF	Steel
J3BF3	3/8"	3/8"-19 BSPP	Steel
J3F4	3/8"	1/2"-14 NPTF	Steel
J4F3	1/2"	3/8"-18 NPTF	Steel
J4F4	1/2"	1/2"-14 NPTF	Steel
J4BF4	1/2"	1/2"-14 BSPP	Steel
J4F6	1/2"	3/4"-14 NPTF	Steel

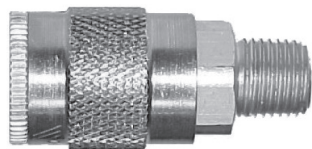

(Male Thread)

J-SERIES TRUFLATE AUTOMOTIVE INTERCHANGE (MANUAL COUPLER)			
PART NO.	BODY SIZE	THREAD SIZE	BODY MATERIAL
2JM1-B	1/4"	1/8"-27 NPTF	Brass
2JM2-B	1/4"	1/4"-18 NPTF	Brass
2JM3-B	1/4"	3/8"-18 NPTF	Brass
3JM2	3/8"	1/4"-18 NPTF	Steel
3JM3	3/8"	3/8"-18 NPTF	Steel
3JM4	3/8"	1/2"-14 NPTF	Steel
4FM3	1/2"	3/8"-18 NPTF	Steel
4FM4	1/2"	1/2"-14 NPTF	Steel
4FM6	1/2"	3/4"-14 NPTF	Steel



(Male Thread)

J-SERIES TRUFLATE AUTOMOTIVE INTERCHANGE (NIPPLE)			
PART NO.	BODY SIZE	THREAD SIZE	BODY MATERIAL
J2M1	1/4"	1/8"-27 NPTF	Steel
J2M2	1/4"	1/4"-18 NPTF	Steel
J2M2-B	1/4"	1/4"-18 NPTF	Brass
J2M3	1/4"	3/8"-18 NPTF	Steel
J3M2	3/8"	1/4"-18 NPTF	Steel
J3M3	3/8"	3/8"-18 NPTF	Steel
J3M4	3/8"	1/2"-14 NPTF	Steel
J4M3	1/2"	3/8"-18 NPTF	Steel
J4M4	1/2"	1/2"-14 NPTF	Steel
J4M6	1/2"	3/4"-14 NPTF	Steel

V

## J-SERIES TRUFLATE AUTOMOTIVE INTERCHANGE (NIPPLE)



(Standard & Push-Loc Hose Barb)

PART NO.	BODY SIZE	BARB CONFIGURATION	BODY MATERIAL
J2S2	1/4"	1/4" Hose Barb	Steel
J2B2	1/4"	1/4" Push-Loc	Steel
J2S2.5	1/4"	5/16" Hose Barb	Steel
J2S3	1/4"	3/8" Hose Barb	Steel
J2B3	1/4"	3/8" Push-Loc	Steel
J3S2	3/8"	1/4" Hose Barb	Steel
J3S3	3/8"	3/8" Hose Barb	Steel
J3B3	3/8"	3/8" Push-Loc	Steel
J3S4	3/8"	1/2" Hose Barb	Steel
J4S3	1/2"	3/8" Hose Barb	Steel
J4S4	1/2"	1/2" Hose Barb	Steel
J4B4	1/2"	1/2" Push-Loc	Steel
J4S6	1/2"	3/4" Hose Barb	Steel

## J-SERIES TRUFLATE AUTOMOTIVE INTERCHANGE (MANUAL COUPLER)

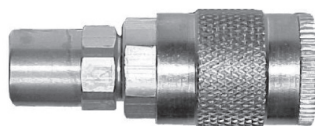

(Reusable Barb)

PART NO.	BODY SIZE	BARB CONFIGURATION	BODY MATERIAL
2JE2-B	1/4"	1/4" ID X 3/8" OD	Brass
2JH2-B	1/4"	1/4" ID X 5/8" OD	Brass
2JK3-B	1/4"	3/8" ID X 11/16" OD	Brass
2JL3-B	1/4"	3/8" ID X 3/4" OD	Brass

## J-SERIES TRUFLATE AUTOMOTIVE INTERCHANGE (NIPPLE)

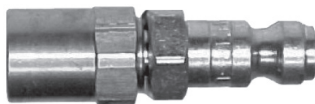

(Reusable Barb)

PART NO.	BODY SIZE	BARB CONFIGURATION	BODY MATERIAL
J2E2	1/4"	1/4" ID X 3/8" OD	Steel
J2H2	1/4"	1/4" ID X 5/8" OD	Steel
J2K3	1/4"	3/8" ID X 11/16" OD	Steel
J2L3	1/4"	3/8" ID X 3/4" OD	Steel

## J-SERIES TRUFLATE AUTOMOTIVE INTERCHANGE (MANUAL COUPLER)

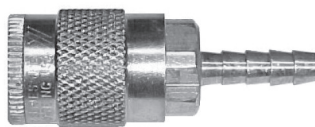

(Standard & Push-Loc Hose Barb)

PART NO.	BODY SIZE	BARB CONFIGURATION	BODY MATERIAL
2JS2-B	1/4"	1/4" Hose Barb	Brass
2JB2-B	1/4"	1/4" Push-Loc	Brass
2JS2.5-B	1/4"	5/16" Hose Barb	Brass
2JS3-B	1/4"	3/8" Hose Barb	Brass
2JB3-B	1/4"	3/8" Push-Loc	Brass
3JS2	3/8"	1/4" Hose Barb	Steel
3JS3	3/8"	3/8" Hose Barb	Steel
3JB3	3/8"	3/8" Push-Loc	Steel
3JS4	3/8"	1/2" Hose Barb	Steel
4FS3	1/2"	3/8" Hose Barb	Steel
4FS4	1/2"	1/2" Hose Barb	Steel
4FB4	1/2"	1/2" Push-Loc	Steel
4FS6	1/2"	3/4" Hose Barb	Steel

## CJ-Series European High-Flow Interchange

### Interchange Data:

- European High-Flow Interchange
- 1/4" interchanges with Coilhose Megaflow, CEJN 320, and Rectus 25KA/26KA
- 3/8" interchanges with Rectus 27KA and Series 410

### Materials:

- Machined components are manufactured using solid Steel or Brass bar stock
- Stainless Steel balls, retaining rings, and springs maximise corrosion resistance and extend service life
- Steel componentry is plated using ROHS Compliant Trivalent Chrome.
- 3/8" and 1/2" couplers constructed of Steel as standard with Steel tubular valves



### Seal Components:

- Nitrile (Buna-N) pneumatically energised seals are standard, providing a temperature range of -40°C to +121°C (-40°F to +250°F)

### Rated Pressure Chart:

CJ-SERIES EUROPEAN HIGH-FLOW INTERCHANGE (CONNECTED)								
BODY SIZE	BRASS COUPLER/STEEL PLUG				BRASS COUPLER/PLUG			
	Max. Working		Burst		Max. Working		Burst	
	PSI	Bar	PSI	Bar	PSI	Bar	PSI	Bar
1/4"	300	20	9,500	655	300	20	7,200	500
3/8"	300	20	8,000	552	300	20	4,400	300

### Technical Specifications:

BODY SIZE	INTERCHANGE STANDARDS				FUNCTIONAL PARAMETERS				
	U.S. MILITARY	U.S. GOVERNMENT	INTERNATIONAL STANDARDS	ANSI/NFPA STANDARDS	LOCKING BALL QUANTITY	AIR INCLUSION	FLUID LOSS	VACUUM INCH HG	FLOW ΔP = 15 PSI CFM
1/4"	-	-	-	-	6	N/A	N/A	N/R	37
3/8"	-	-	-	-	6	N/A	N/A	N/R	67

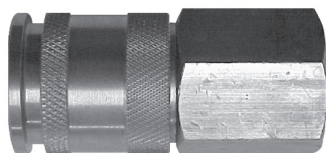

(Female Thread)

## CJ-SERIES EUROPEAN INTERCHANGE (AUTOMATIC COUPLER)

PART NO.	BODY SIZE	THREAD SIZE	BODY MATERIAL
2CJF2-B	1/4"	1/4"-18 NPT	Brass
2CJBF2-B	1/4"	1/4"-19 BSPP	Brass
2CJF3-B	1/4"	3/8"-18 NPT	Brass
2CJBF3-B	1/4"	3/8"-19 BSPP	Brass
3CJF3-B	3/8"	3/8"-18 NPT	Brass
3CJBF3-B	3/8"	3/8"-19 BSPP	Brass
3CJF4-B	3/8"	1/2"-14 NPT	Brass
3CJBF4-B	3/8"	1/2"-14 BSPP	Brass

## CJ-SERIES EUROPEAN INTERCHANGE (NIPPLE)

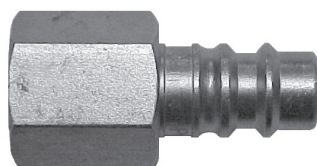

(Female Thread)

PART NO.	BODY SIZE	THREAD SIZE	BODY MATERIAL
CJ2F2-LG	1/4"	1/4"-18 NPT	Steel
CJ2F2-B	1/4"	1/4"-18 NPT	Brass
CJ2BF2-LG	1/4"	1/4"-19 BSPP	Steel
CJ2BF2-B	1/4"	1/4"-19 BSPP	Brass
CJ2F3-LG	1/4"	3/8"-18 NPT	Steel
CJ2F3-B	1/4"	3/8"-18 NPT	Brass
CJ2BF3-LG	1/4"	3/8"-19 BSPP	Steel
CJ2BF3-B	1/4"	3/8"-19 BSPP	Brass
CJ3F3	3/8"	3/8"-18 NPT	Steel
CJ3BF3	3/8"	3/8"-19 BSPP	Steel
CJ3F4	3/8"	1/2"-14 NPT	Steel
CJ3BF4	3/8"	1/2"-14 BSPP	Steel

## CJ-SERIES EUROPEAN INTERCHANGE (AUTOMATIC COUPLER)

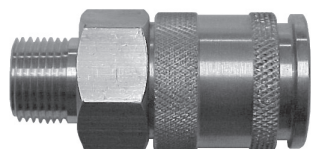

(Male Thread)

PART NO.	BODY SIZE	THREAD SIZE	BODY MATERIAL
2CJM2-B	1/4"	1/4"-18 NPT	Brass
2CJBM2-B	1/4"	1/4"-19 BSPT	Brass
2CJM3-B	1/4"	3/8"-18 NPT	Brass
2CJBM3-B	1/4"	3/8"-19 BSPT	Brass
3CJM3-B	3/8"	3/8"-18 NPT	Brass
3CJBM3-B	3/8"	3/8"-19 BSPT	Brass
3CJM4-B	3/8"	1/2"-14 NPT	Brass
3CJBM4-B	3/8"	1/2"-14 BSPT	Brass

## CJ-SERIES EUROPEAN INTERCHANGE (NIPPLE)



(Male Thread)

PART NO.	BODY SIZE	THREAD SIZE	BODY MATERIAL
CJ2M2-LG	1/4"	1/4"-18 NPT	Steel
CJ2M2-B	1/4"	1/4"-18 NPT	Brass
CJ2BM2-LG	1/4"	1/4"-19 BSP	Steel
CJ2BM2-B	1/4"	1/4"-19 BSP	Brass
CJ2M3-LG	1/4"	3/8"-18 NPT	Steel
CJ2M3-B	1/4"	3/8"-18 NPT	Brass
CJ2BM3-LG	1/4"	3/8"-19 BSP	Steel
CJ2BM3-B	1/4"	3/8"-19 BSP	Brass
CJ3M3	3/8"	3/8"-18 NPT	Steel
CJ3BM3	3/8"	3/8"-19 BSP	Steel
CJ3M4	3/8"	1/2"-14 NPT	Steel
CJ3BM4	3/8"	1/2"-14 BSP	Steel

# Quick Release Couplings

## N Series Bowes/MacDonald Interchange

### Interchange Data:

- Bowes Interchange Bayonet Style
- Interchangeable with Bowes 51000-Series, National Series 'B', Dixon Dixlock, MacDonald Quick-Action, Adlock

### Materials:

- Machined components are manufactured using solid Steel, Brass, or 303 Stainless Steel bar stock
- Phosphor Bronze retaining ring and spring maximise corrosion resistance and extend service life
- Steel componentry is plated using ROHS Compliant Trivalent Chrome
- Dust cap bead chain constructed of Stainless Steel



### Seal Components:

- Nitrile (Buna-N) pneumatically energised seals are standard, temperature range -40°C to +121°C (-40°F to +250°F)

### Rated Pressure Chart:

N-SERIES BOWES INTERCHANGE (CONNECTED)												
BODY SIZE	STEEL COUPLER/PLUG				BRASS COUPLER/PLUG				303 STAINLESS STEEL COUPLER/PLUG			
	Max. Working		Burst		Max. Working		Burst		Max. Working		Burst	
	PSI	Bar	PSI	Bar	PSI	Bar	PSI	Bar	PSI	Bar	PSI	Bar
3/8"	500	35	7,000	480	-	-	-	-	-	-	-	-
1/2"	500	35	11,000	755	300	20	8,200	-	500	35	12,600	-

### Technical Specifications:

BODY SIZE	INTERCHANGE STANDARDS				FUNCTIONAL PARAMETERS				
	U.S. MILITARY	U.S. GOVERNMENT	INTERNATIONAL STANDARDS	ANSI/NFPA STANDARDS	LOCKING BALL QUANTITY	AIR INCLUSION	FLUID LOSS	VACUUM INCH HG	FLOW ΔP = 10 PSI CFM
3/8"	-	-	-	-	Latch Tabs	N/A	N/A	N/R	108
1/2"	MIL-C-3486	A-A-50431A	-	-	Latch Tabs	N/A	N/A	N/R	204

It is important to be safe when installing quick disconnect couplings into a pneumatic circuit. Never install a pneumatic coupling directly into an air tool, use a piece of hose that is at least 18" long, between the tool and the coupling, to prevent damage to the coupling. To protect the operator, safety devices, such as a safety check valve and safety cable should be installed in case there is a hose or coupling failure.

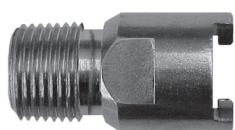

(Male Thread)

N-SERIES BOWES INTERCHANGE (COUPLER)			
PART NO.	BODY SIZE	THREAD SIZE	BODY MATERIAL
3NM4	3/8"	1/2"-14 NPTF	Steel
3NBM4	3/8"	1/2"-14 BSPT	Steel



(Male Thread)

N-SERIES BOWES INTERCHANGE (NIPPLE)			
PART NO.	BODY SIZE	THREAD SIZE	BODY MATERIAL
N3M4	3/8"	1/2"-14 NPTF	Steel
N3BM4	3/8"	1/2"-14 BSPT	Steel





(Collar Barb)

## N-SERIES BOWES INTERCHANGE (COUPLER)

PART NO.	BODY SIZE	BARB CONFIGURATION	BODY MATERIAL
3NCS4	3/8"	1/2" Collar Barb	Steel



(Female Thread)

## N-SERIES MACDONALD INTERCHANGE (UNVALVED COUPLER)

PART NO.	BODY SIZE	THREAD SIZE	BODY MATERIAL
4NF3	1/2"	3/8"-18 NPTF	Steel
4NF3-B	1/2"	3/8"-18 NPTF	Brass
4NBF3	1/2"	3/8"-19 BSPP	Steel
4NF4	1/2"	1/2"-14 NPTF	Steel
4NF4-B	1/2"	1/2"-14 NPTF	Brass
4NBF4	1/2"	1/2"-14 BSPP	Steel
4NBF4-B	1/2"	1/2"-14 BSPP	Brass
4NF6	1/2"	3/4"-14 NPTF	Steel
4NF6-B	1/2"	3/4"-14 NPTF	Brass
4NF6-S	1/2"	3/4"-14 NPTF	303 Stainless Steel
4NBF6	1/2"	3/4"-14 BSPP	Steel
4NBF6-B	1/2"	3/4"-14 BSPP	Brass
4NF8	1/2"	1"-11 1/2 NPTF	Steel
4NF8-B	1/2"	1"-11 1/2 NPTF	Brass
4NBF8	1/2"	1"-11 BSPP	Steel
4NBF8-B	1/2"	1"-11 BSPP	Brass

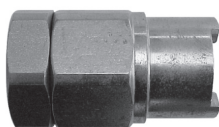

(Female Thread)

## N-SERIES MACDONALD INTERCHANGE (VALVED COUPLER)

PART NO.	BODY SIZE	THREAD SIZE	BODY MATERIAL
4NF6-V	1/2"	3/4"-14 NPTF	Steel
4NBF6-V	1/2"	3/4"-14 BSPP	Steel



(Female Thread)

## N-SERIES MACDONALD INTERCHANGE (NIPPLE)

PART NO.	BODY SIZE	THREAD SIZE	BODY MATERIAL
N4F3	1/2"	3/8"-18 NPTF	Steel
N4F3-B	1/2"	3/8"-18 NPTF	Brass
N4BF3	1/2"	3/8"-19 BSPP	Steel
N4F4	1/2"	1/2"-14 NPTF	Steel
N4F4-B	1/2"	1/2"-14 NPTF	Brass
N4BF4	1/2"	1/2"-14 BSPP	Steel
N4BF4-B	1/2"	1/2"-14 BSPP	Brass
N4F6	1/2"	3/4"-14 NPTF	Steel
N4F6-B	1/2"	3/4"-14 NPTF	Brass
N4F6-S	1/2"	3/4"-14 NPTF	303 Stainless Steel
N4BF6	1/2"	3/4"-14 BSPP	Steel
N4BF6-B	1/2"	3/4"-14 BSPP	Brass
N4F8	1/2"	1"-11 1/2 NPTF	Steel
N4F8-B	1/2"	1"-11 1/2 NPTF	Brass
N4BF8	1/2"	1"-11 BSPP	Steel
N4BF8-B	1/2"	1"-11 BSPP	Brass

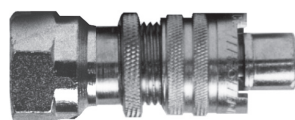

(Female Thread)

## N-SERIES MACDONALD INTERCHANGE (SAFETY-LOCK NIPPLE)

PART NO.	BODY SIZE	THREAD SIZE	BODY MATERIAL
N4F4-B-LS	1/2"	1/2"-14 NPTF	Brass
N4F6-B-LS	1/2"	3/4"-14 NPTF	Brass

# Quick Release Couplings

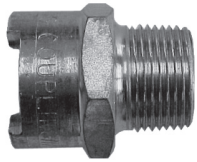

(Male Thread)

N-SERIES MACDONALD INTERCHANGE (UNVALVED COUPLER)			
PART NO.	BODY SIZE	THREAD SIZE	BODY MATERIAL
4NM3	1/2"	3/8"-18 NPTF	Steel
4NM3-B	1/2"	3/8"-18 NPTF	Brass
4NBM3	1/2"	3/8"-19 BSPT	Steel
4NM4	1/2"	1/2"-14 NPTF	Steel
4NM4-B	1/2"	1/2"-14 NPTF	Brass
4NBM4	1/2"	1/2"-14 BSPT	Steel
4NBM4-B	1/2"	1/2"-14 BSPT	Brass
4NM6	1/2"	3/4"-14 NPTF	Steel
4NM6-B	1/2"	3/4"-14 NPTF	Brass
4NM6-S	1/2"	3/4"-14 NPTF	303 Stainless Steel
4NBM6	1/2"	3/4"-14 BSPT	Steel
4NBM6-B	1/2"	3/4"-14 BSPT	Brass
4NM8	1/2"	1"-11 1/2 NPTF	Steel
4NM8-B	1/2"	1"-11 1/2 NPTF	Brass
4NBM8	1/2"	1"-11 BSPT	Steel
4NBM8-B	1/2"	1"-11 BSPT	Brass

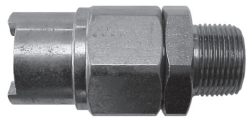

(Male Thread)

N-SERIES MACDONALD INTERCHANGE (VALVED COUPLER)			
PART NO.	BODY SIZE	THREAD SIZE	BODY MATERIAL
4NM6-V	1/2"	3/4"-14 NPTF	Steel



(Male Thread)

N-SERIES MACDONALD INTERCHANGE (NIPPLE)			
PART NO.	BODY SIZE	THREAD SIZE	BODY MATERIAL
N4M3	1/2"	3/8"-18 NPTF	Steel
N4M3-B	1/2"	3/8"-18 NPTF	Brass
N4BM3	1/2"	3/8"-19 BSPT	Steel
N4M4	1/2"	1/2"-14 NPTF	Steel
N4M4-B	1/2"	1/2"-14 NPTF	Brass
N4BM4	1/2"	1/2"-14 BSPT	Steel
N4BM4-B	1/2"	1/2"-14 BSPT	Brass
N4M6	1/2"	3/4"-14 NPTF	Steel
N4M6-B	1/2"	3/4"-14 NPTF	Brass
N4M6-S	1/2"	3/4"-14 NPTF	303 Stainless Steel
N4BM6	1/2"	3/4"-14 BSPT	Steel
N4BM6-B	1/2"	3/4"-14 BSPT	Brass
N4M8	1/2"	1"-11 1/2 NPTF	Steel
N4M8-B	1/2"	1"-11 1/2 NPTF	Brass
N4BM8	1/2"	1"-11 BSPT	Steel
N4BM8-B	1/2"	1"-11 BSPT	Brass

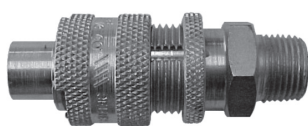

(Male Thread)

N-SERIES MACDONALD INTERCHANGE (SAFETY-LOCK NIPPLE)			
PART NO.	BODY SIZE	THREAD SIZE	BODY MATERIAL
N4M4-LS	1/2"	1/2"-14 NPTF	Steel
N4M4-B-LS	1/2"	1/2"-14 NPTF	Brass
N4BM4-LS	1/2"	1/2"-14 BSPT	Steel
N4M6-LS	1/2"	3/4"-14 NPTF	Steel
N4M6-B-LS	1/2"	3/4"-14 NPTF	Brass
N4M6-S-LS	1/2"	3/4"-14 NPTF	303 Stainless Steel
N4BM6-LS	1/2"	3/4"-14 BSPT	Steel

X





(Hose Barb - now accepts light duty ferrules)

## N-SERIES MACDONALD INTERCHANGE (COUPLER)

PART NO.	BODY SIZE	BARB CONFIGURATION	BODY MATERIAL
4NS3	1/2"	3/8" Hose Barb	Steel
4NS3-B	1/2"	3/8" Hose Barb	Brass
4NS4	1/2"	1/2" Hose Barb	Steel
4NS4-B	1/2"	1/2" Hose Barb	Brass
4NS6	1/2"	3/4" Hose Barb	Steel
4NS6-B	1/2"	3/4" Hose Barb	Brass
4NS6-S	1/2"	3/4" Hose Barb	303 Stainless Steel
4NS8	1/2"	1" Hose Barb	Steel
4NS8-B	1/2"	1" Hose Barb	Brass

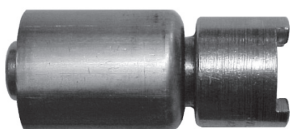

(Hose Barb with Staked Ferrule)

## N-SERIES MACDONALD INTERCHANGE (COUPLER)

PART NO.	BODY SIZE	HOSE (ID) OD RANGE	BODY MATERIAL
4NCS4-WF43	1/2"	(1/2") 27/32" to 11/32"	Steel
4NCS4-B-WF43	1/2"	(1/2") 27/32" to 11/32"	Brass
4NCS6-WF63	1/2"	(3/4") 15/32" to 11/32"	Steel
4NCS6-B-WF63	1/2"	(3/4") 15/32" to 11/32"	Brass
4NCS6-S-WFS63	1/2"	(3/4") 15/32" to 11/32"	303 Stainless Steel



(Hose Barb - now accepts light duty ferrules)

## N-SERIES MACDONALD INTERCHANGE (NIPPLE)

PART NO.	BODY SIZE	BARB CONFIGURATION	BODY MATERIAL
N4S3	1/2"	3/8" Hose Barb	Steel
N4S3-B	1/2"	3/8" Hose Barb	Brass
N4S4	1/2"	1/2" Hose Barb	Steel
N4S4-B	1/2"	1/2" Hose Barb	Brass
N4S6	1/2"	3/4" Hose Barb	Steel
N4S6-B	1/2"	3/4" Hose Barb	Brass
N4S6-S	1/2"	3/4" Hose Barb	303 Stainless Steel
N4S8	1/2"	1" Hose Barb	Steel
N4S8-B	1/2"	1" Hose Barb	Brass

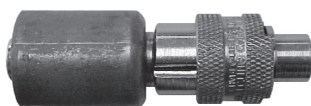

(Hose Barb with Staked Ferrule)

## N-SERIES MACDONALD INTERCHANGE (NIPPLE)

PART NO.	BODY SIZE	HOSE (ID) OD RANGE	BODY MATERIAL
N4CS4-WF43	1/2"	(1/2") 27/32" to 11/32"	Steel
N4CS4-B-WF43	1/2"	(1/2") 27/32" to 11/32"	Brass
N4CS6-WF63	1/2"	(3/4") 15/32" to 11/32"	Steel
N4CS6-B-WF63	1/2"	(3/4") 15/32" to 11/32"	Brass
N4CS6-S-WFS63	1/2"	(3/4") 15/32" to 11/32"	303 Stainless Steel

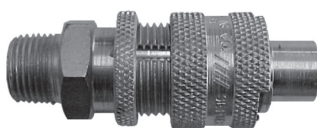

(Hose Barb - now accepts light duty ferrules)

## N-SERIES MACDONALD INTERCHANGE (SAFETY-LOCK NIPPLE)

PART NO.	BODY SIZE	BARB CONFIGURATION	BODY MATERIAL
N4S4-LS	1/2"	1/2" Hose Barb	Steel
N4S4-B-LS	1/2"	1/2" Hose Barb	Brass
N4S6-LS	1/2"	3/4" Hose Barb	Steel
N4S6-B-LS	1/2"	3/4" Hose Barb	Brass
N4S6-S-LS	1/2"	3/4" Hose Barb	303 Stainless Steel

# Quick Release Couplings

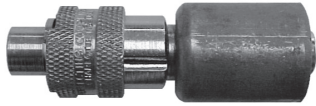

(Hose Barb with Staked Ferrule)

## N-SERIES MACDONALD INTERCHANGE (SAFETY-LOCK NIPPLE)

PART NO.	BODY SIZE	HOSE (ID) OD RANGE	BODY MATERIAL
N4CS4-LS-WF43	1/2"	(1/2") 27/32" to 11/32"	Steel
N4CS4-B-LS-WF43	1/2"	(1/2") 27/32" to 11/32"	Brass
N4CS6-LS-WF63	1/2"	(3/4") 15/32" to 11/32"	Steel
N4CS6-B-LS-WF63	1/2"	(3/4") 15/32" to 11/32"	Brass
N4CS6-S-LS-WFS63	1/2"	(3/4") 15/32" to 11/32"	303 Stainless Steel



(Female Thread)

## N-SERIES BOWES INTERCHANGE (COUPLER)

PART NO.	BODY SIZE	THREAD SIZE	BODY MATERIAL
10NF8-B	1 1/4"	1"-11 1/2 NPTF	Brass
10NF10-B	1 1/4"	1 1/4"-11 1/2 NPTF	Brass

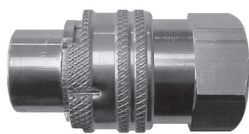

(Female Thread)

## N-SERIES BOWES INTERCHANGE (NIPPLE)

PART NO.	BODY SIZE	THREAD SIZE	BODY MATERIAL
N10F8-B	1 1/4"	1"-11 1/2 NPTF	Brass
N10F10-B	1 1/4"	1 1/4"-11 1/2 NPTF	Brass

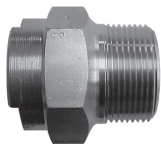

(Male Thread)

## N-SERIES BOWES INTERCHANGE (COUPLER)

PART NO.	BODY SIZE	THREAD SIZE	BODY MATERIAL
10NM8-B	1 1/4"	1"-11 1/2 NPTF	Brass
10NM10-B	1 1/4"	1 1/4"-11 1/2 NPTF	Brass

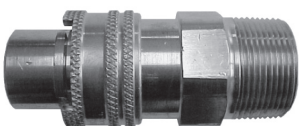

(Male Thread)

## N-SERIES BOWES INTERCHANGE (NIPPLE)

PART NO.	BODY SIZE	THREAD SIZE	BODY MATERIAL
N10M8-B	1 1/4"	1"-11 1/2 NPTF	Brass
N10M10-B	1 1/4"	1 1/4"-11 1/2 NPTF	Brass

X

A Safety Check Valve, also known as an Excessive Flow Sensor should be installed at the source of supply to protect the operator in case of coupling failure or hose rupture.

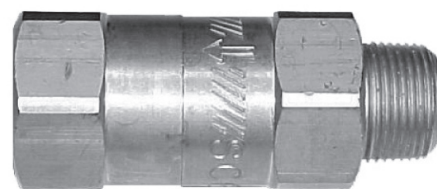

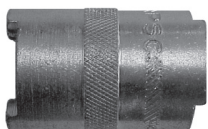

## N-SERIES MACDONALD INTERCHANGE (GENDER-CHANGE UNION)

PART NO.	BODY SIZE	PART DESCRIPTION	BODY MATERIAL
4N4N	1/2"	Coupler to Coupler	Steel



## N-SERIES MACDONALD INTERCHANGE (Y-COUPPLERS)

PART NO.	BODY SIZE	INLET/OUTLET CONFIGURATION	BODY MATERIAL
N4Y4N-4N	1/2"	Nipple to Couplers	Steel



## N-SERIES MACDONALD INTERCHANGE (Y-NIPPLES)

PART NO.	BODY SIZE	INLET/OUTLET CONFIGURATION	BODY MATERIAL
4NYN4-N4	1/2"	Nipple to Couplers	Steel

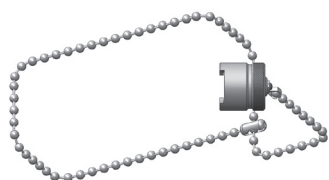

## N-SERIES BOWES INTERCHANGE PROTECTIVE NIPPLE CAP

PART NO	BODY SIZE	LANYARD	BODY
N4DC	1/2"	SS bead chain	Steel
N4DC-B	1/2"	SS bead chain	Brass

## P-Series Thor Interchange

### Interchange Data:

- Thor Finger-Lock Interchange
- Interchanges with Thor PHC-Series, National Series 'A', and Dixon Dual-Lock.

### Materials:

- Machined components are manufactured using solid Steel, Brass, or 303 Stainless Steel bar stock.
- Phosphor Bronze retaining ring and spring maximise corrosion resistance and extend service life.
- Steel componentry is plated using ROHS Compliant Trivalent Chrome.
- Steel couplings have a Zinc Cast sleeve



### Seal Components:

- Nitrile (Buna-N) seals are standard, temperature range -40°C to +121°C (-40°F to +250°F)

### Rated Pressure Chart:

P-SERIES THOR INTERCHANGE (CONNECTED)												
BODY SIZE	STEEL COUPLER/PLUG				BRASS COUPLER/PLUG				303 STAINLESS STEEL COUPLER/PLUG			
	Max. Working		Burst		Max. Working		Burst		Max. Working		Burst	
	PSI	Bar	PSI	Bar	PSI	Bar	PSI	Bar	PSI	Bar	PSI	Bar
1/2"	300	20	2,600	180	300	20	3,500	240	300	20	4,500	310

### Technical Specifications:

BODY SIZE	INTERCHANGE STANDARDS				FUNCTIONAL PARAMETERS					
	U.S. MILITARY	U.S. GOVERNMENT	INTERNATIONAL STANDARDS	ANSI/NFPA STANDARDS	LOCKING QUANTITY	AIR INCLUSION	FLUID LOSS	VACUUM INCH HG	FLOW ΔP = 15 PSI CFM	
1/2"	-	-	-	-	Latch Fingers	N/A	N/A	N/R	255	

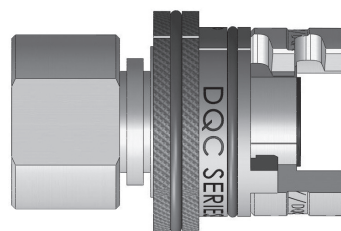

P Series Coupler with -FS] Flanged Sleeve Option



(Female Thread)

## P-SERIES THOR INTERCHANGE (COUPLER)

PART NO.	BODY SIZE	THREAD SIZE	BODY MATERIAL
4PF4	1/2"	1/2"-14 NPTF	Steel
4PF6	1/2"	3/4"-14 NPTF	Steel
4PF6-B	1/2"	3/4"-14 NPTF	Brass
4PF6-S	1/2"	3/4"-14 NPTF	303 Stainless Steel

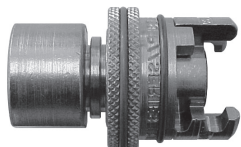

(Female Thread)

## P-SERIES THOR INTERCHANGE (FLANGED-SLEEVE COUPLER)

PART NO.	BODY SIZE	THREAD SIZE	BODY MATERIAL
4PF4-FS	1/2"	1/2"-14 NPTF	Steel
4PF6-FS	1/2"	3/4"-14 NPTF	Steel

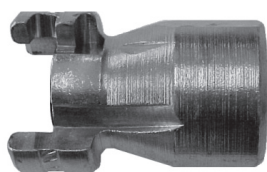

(Female Thread)

## P-SERIES THOR INTERCHANGE (NIPPLE)

PART NO.	BODY SIZE	THREAD SIZE	BODY MATERIAL
P4F3	1/2"	3/8"-18 NPTF	Steel
P4F4	1/2"	1/2"-14 NPTF	Steel
P4F4-B	1/2"	1/2"-14 NPTF	Brass
P4F6	1/2"	3/4"-14 NPTF	Steel
P4F6-B	1/2"	3/4"-14 NPTF	Brass
P4F6-S	1/2"	3/4"-14 NPTF	303 Stainless Steel
P4F8	1/2"	1"-11 1/2 NPTF	Steel
P4F8-B	1/2"	1"-11 1/2 NPTF	Brass



(Male Thread)

## P-SERIES THOR INTERCHANGE (COUPLER)

PART NO.	BODY SIZE	THREAD SIZE	BODY MATERIAL
4PM3	1/2"	3/8"-18 NPTF	Steel
4PM4	1/2"	1/2"-14 NPTF	Steel
4PM6	1/2"	3/4"-14 NPTF	Steel
4PM6-S	1/2"	3/4"-14 NPTF	303 Stainless Steel



(Male Thread)

## P-SERIES THOR INTERCHANGE (FLANGED-SLEEVE COUPLER)

PART NO.	BODY SIZE	THREAD SIZE	PART MATERIAL
4PM3-FS	1/2"	3/8"-18 NPTF	Steel
4PM4-FS	1/2"	1/2"-14 NPTF	Steel
4PM6-FS	1/2"	3/4"-14 NPTF	Steel

# Quick Release Couplings

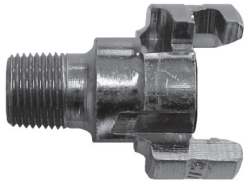

(Male Thread)

## P-SERIES THOR INTERCHANGE (NIPPLE)

PART NO.	BODY SIZE	THREAD SIZE	BODY MATERIAL
P4M3	1/2"	3/8"-18 NPTF	Steel
P4M4	1/2"	1/2"-14 NPTF	Steel
P4M4-B	1/2"	1/2"-14 NPTF	Brass
P4M6	1/2"	3/4"-14 NPTF	Steel
P4M6-B	1/2"	3/4"-14 NPTF	Brass
P4M6-S	1/2"	3/4"-14 NPTF	303 Stainless Steel
P4M8	1/2"	1"-11 1/2 NPTF	Steel
P4M8-B	1/2"	1"-11 1/2 NPTF	Brass



(Hose Barb - now accepts light duty ferrules)

## P-SERIES THOR INTERCHANGE (COUPLER)

PART NO.	BODY SIZE	BARB CONFIGURATION	BODY MATERIAL
4PS3	1/2"	3/8" Hose Barb	Steel
4PS4	1/2"	1/2" Hose Barb	Steel
4PS4-B	1/2"	1/2" Hose Barb	Brass
4PS6	1/2"	3/4" Hose Barb	Steel
4PS6-B	1/2"	3/4" Hose Barb	Brass
4PS6-S	1/2"	3/4" Hose Barb	303 Stainless Steel
4PS8	1/2"	1" Hose Barb	Steel
4PS8-B	1/2"	1" Hose Barb	Brass

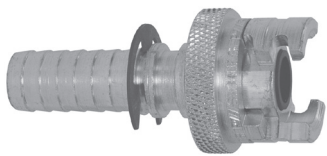

(Hose Barb - now accepts light duty ferrules)

## P-SERIES THOR INTERCHANGE (FLANGED-SLEEVE COUPLER)

PART NO.	BODY SIZE	BARB CONFIGURATION	BODY MATERIAL
4PS3-FS	1/2"	3/8" Hose Barb	Steel
4PS4-FS	1/2"	1/2" Hose Barb	Steel
4PS6-FS	1/2"	3/4" Hose Barb	Steel
4PS8-FS	1/2"	1" Hose Barb	Steel

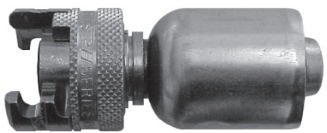

(Hose Barb with Staked Ferrule)

## P-SERIES THOR INTERCHANGE (COUPLER)

PART NO.	BODY SIZE	HOSE (ID) OD RANGE	BODY MATERIAL
4PCS4-WF43	1/2"	(1/2") 27/32" to 11/32"	Steel
4PCS4-B-WF43	1/2"	(1/2") 27/32" to 11/32"	Brass
4PCS6-WF63	1/2"	(3/4") 15/32" to 11/32"	Steel
4PCS6-B-WF63	1/2"	(3/4") 15/32" to 11/32"	Brass

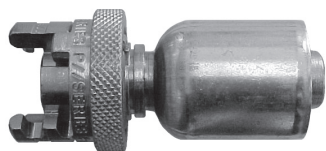

(Hose Barb with Staked Ferrule)

## P-SERIES THOR INTERCHANGE (FLANGED-SLEEVE COUPLER)

PART NO.	BODY SIZE	HOSE (ID) OD RANGE	BODY MATERIAL
4PCS4-FS-WF43	1/2"	(1/2") 27/32" to 11/32"	Steel
4PCS6-FS-WF63	1/2"	(3/4") 15/32" to 11/32"	Steel

Y

## Dry Disconnect Couplings

When your product is:

- Expensive
- Expensive to clean up
- Expensive to reprocess or dispose
- Hazardous to workers or the environment
- Prone to accidental spillage and product loss

Dry Disconnect Couplings are designed for quick and spill free connection and disconnection of hoses and pipelines. They are used by producers of ink, adhesives, fatty acids, pharmaceuticals, liquid soaps, petroleum, chemicals, agricultural and a wide variety of common caustic and specialty acids.



- **Easy to handle -**  
Push and turn - free flow, turn and pull - closed
- **Time saving-**  
No need to drain hoses or pipe systems
- **Economical-**  
No loss or spillage of liquids at connection or disconnection
- **Safety-**  
The valve cannot be opened until the unit is coupled
- **Environment friendly-**  
Accidental spillage eliminated
- **Safe and reliable-**  
Due to rugged construction

- **Selectivity-**  
Optional selectivity for preventing contamination due to incorrect and cross-coupling
- **Product life-**  
Uncomplicated design and high quality materials ensures longer product life
- **Working Pressure -**

Aluminium:	260 psi / 18 bar
Brass/ Gunmetal:	360 psi / 25 bar
Stainless Steel:	360 psi / 25 bar
- **Optional Seals-**

EPDM	BR - nitrile
Kalrez®	Chemraz®
Perlast®	

Interchanges with Avery Hardoll and Todo-matic®

## How it works

The principle of operation is identical for all sizes of couplings.

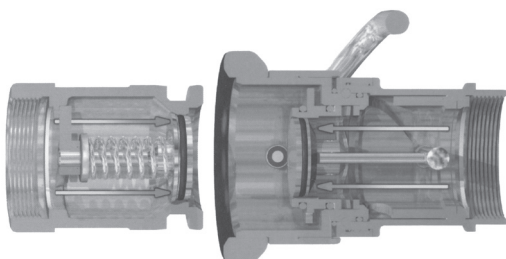

### CLOSED:

- Turn and pull  
It's released - no spillage

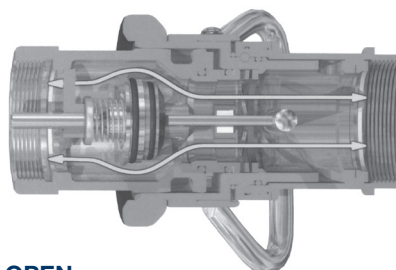

### OPEN:

- Push and turn  
It's coupled - full flow

## Dry Disconnect Cam & Groove Couplings

### Application:

For the bulk transfer of petroleum and gas, while ensuring a quick and spill-free connection.

### General Features:

- Compatible with most cam and groove style dry disconnects
- Spring loaded sealing device designed to "snap" closed should the valve become disconnected with the poppet open
- Contact Dixon for chemical compatibility, size, and material selection
- Special configurations can be designed for your application

### Adapter Features:

- Two-piece adapter design for easy rebuilding of adapters
- Fully interchangeable with Kamvalok® style fittings
- Aluminium fittings have aluminium nose piece and Brass piston

### Coupler Features:

- Dixon EZ Boss-Lock cam arms provide security from accidental opening due to vibration or snagging
- Heavy duty Stainless Steel crank and link provides long service life
- Dry disconnect coupler has automatic closing poppet assembly
- Stainless Steel handle allows product exposure to corrosive chemicals or wash down service
- Strong handle attachment prevents sheared pins and misaligned crank assemblies
- Fully interchangeable with Kamvalok® style fittings
- Aluminium fittings have Stainless Steel (corrosion resistance comparable to 304 stainless) internals

**A DBA style adapter (sold separately) is required for the coupler to operate** ▲

### Sizes:

Available in 1½", 2" and 3" female NPT x coupler 2", 2½" and 4".  
Available in 1½", 2" and 3" female NPT x adapter 2", 2½" and 4".

### Materials:

Stainless Steel, aluminium.

Adapter seals- Buna, FKM, PTFE Encapsulated Silicone, EPT, Kalrez®, PTFE Encapsulated FKM.

Coupler seals- Buna, FKM, EPT, PTFE Encapsulated Silicone and Kalrez®, PTFE Encapsulated Silicone and Chemraz®, PTFE Encapsulated FKM and Chemraz®, Kalrez® and PTFE.



1½" and 2" DBA adapter



3" DBA adapter

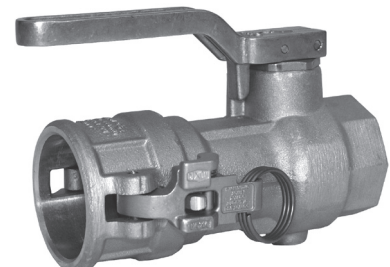

1½" and 2" straight coupler



3" straight coupler

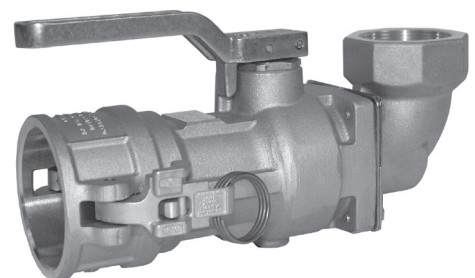

90° swivel

Delrin®, Kevlar® and Zytel® are registered trademarks of E.I. duPont Nemours and Company.  
Kalrez® is a registered trademark of DuPont Dow Elastomers.

Kamvalok® is a registered trademark of OPW Engineered Systems.



## Index

<b>Part No.</b>	<b>Page No.</b>				
		H Series	7-11	Snap-Tite 71 Interchange	35-38
AG Series	18-20	H Series ISO-B	12	Snap-Tite H/H Interchange	50-56
Agricultural Interchange	18-20	HS Series	13-14	ST Series	35-38
Blow Out Prevention Safety Coupling	42-48	High Pressure Coupling	39-41, 45-46, 57-58	S.T.A.M.P.E.D	4
Bowes Interchange	78-83	HT Series	29-32	Steam Interchange	13
BR Series	71-72	HTE Series	33-34	Straight-Through Interchange	61-63
Cejn Interchange	76-77	Industrial Interchange	65-70	T Series	57-58
CJ Series	76-77	ISO 15171-1 Diagnostic Interchange	49	Tema Interchange	23-24
CVW Series	59-60	ISO 16028 Interchange	29-34	Thor Interchange	84-86
DF Series	65-70	ISO 7241 Series A Interchange	15-17	TR Series	23-24
Dry Disconnect Couplings	87	ISO 7241 Series B Interchange	7-14	Truflate Automotive Interchange	73-75
Dry Disconnect Cam & Groove	88	J Series	73-75	V Series	50-56
E Series	61-63	K Series	15-17	VEP Series	21-22
EA Series	64	MacDonald Interchange	78-83	VEP BOP	43-44
Enerpac Interchange	57	N Series	78-83	W Series	25-28
European High Flow Interchange	76-77	Part Number Structure	6	Water Blast Interchange	64
European Screw Together Series	59-60	P Series	84-86	Wing Style Coupling	25-28, 39-41, 45-46
Fluid Compatibility Guide	5	PD Series	49	WS Series	39-41
Flushface Interchange	21-22, 29-34	Rectus 21 Interchange	71-72	WS BOP	45-46
Food Grade Interchange	12	Screw Together Couplings	57-60		

## Dixon Terms & Conditions

### Limited Warranty

Dixon Group Europe Ltd (herein called "Dixon") warrants the products described herein, and manufactured by Dixon to be free from defects in material and workmanship for a period of one (1) year from date of shipment by Dixon under normal use and service. Its sole obligation under this warranty being limited to repairing or replacing, as hereinafter provided, at its option any product found to Dixon's satisfaction to be defective upon examination by it, provided that such product shall be returned for inspection to Dixon's factory within three (3) months after discovery of the defect. The repair or replacement of defective products will be made without charge for parts or labour. This warranty shall not apply to: (a) parts or products not manufactured by Dixon, the warranty of such items being limited to the actual warranty extended to Dixon by its supplier; (b) any product that has been subject to abuse, negligence, accident, or misapplication; (c) any product altered or repaired by others than Dixon; and (d) to normal maintenance services and the replacement of service items (such as washers, gaskets and lubricants) made in connection with such services. To the extent permitted by United Kingdom law, this limited warranty shall extend only to the buyer and any other person reasonably expected to use or consume the goods who is injured in person by any breach of the warranty. No action may be brought against Dixon for an alleged breach of warranty unless such action is instituted within one (1) year from the date the cause of action accrues. This limited warranty shall be construed and enforced to the fullest extent allowable by applicable United Kingdom law.

**OTHER THAN THE OBLIGATION OF DIXON SET FORTH HEREIN, DIXON DISCLAIMS ALL WARRANTIES, EXPRESS OR IMPLIED, INCLUDING BUT NOT LIMITED TO ANY IMPLIED WARRANTIES OF MERCHANTABILITY OR FITNESS FOR A PARTICULAR PURPOSE, AND ANY OTHER OBLIGATION OR LIABILITY. THE FOREGOING CONSTITUTES DIXON'S SOLE OBLIGATION WITH RESPECT TO DAMAGES, WHETHER DIRECT, INCIDENTAL OR CONSEQUENTIAL, RESULTING FROM THE USE OR PERFORMANCE OF THE PRODUCT.**

Some products and sizes may be discontinued when stock is depleted, or may require a minimum quantity for ordering.

Dixon Group Europe Ltd is committed to a policy of continuous development, and as such, the above detailed specification and may be subject to change without notice. Dixon Group Europe Ltd reserves the right to change and modify designs and specification without notice.

### Pricing

Dixon will always try to maintain pricing, however, with the fluctuation of material cost we may be forced to change prices. Please be aware pricing is subject to change without notice.

### Freight/Postage & Carriage Charges

Postage & carriage charges are at the customer's expense and will be charged at current appropriate rates.

### Returns

Dixon will allow its customers to return any product for any reason within 30 days of shipment, provided it is received in a saleable condition. The customer must call to receive a CCR number prior to returning goods to Dixon and shipping will be at the customer's expense, unless it is determined Dixon created the reason for the return.

A re-stocking charge of 25% applies to all returns.

### Limits of Liability

This catalogue is intended as a product offering. It is not intended to be a user or technical manual. Information in this catalogue is subject to change without notice. All users and distributors of products sold through this catalogue should contact Dixon with questions of use, compatibility's, coupling procedures and life of product. Dixon's full time engineering and test staff is always available to recommend uses and to assist distributors and users with questions.

### Copyright

Copyright© 2015 by Dixon Group Europe Ltd.

All rights reserved. This book is copyrighted material. Use, reproduction or copying of it by anyone other than Dixon is strictly forbidden without its express written consent.

10 BAR

DIXON

10 BAR / 700mmHg SF 3:1

18761-2003 A 100 100 TYPE 2 EN 10 BAR

UL S&D UHMWPE 10 BAR / 700mmHg SF 4:1

EN2398 1997 20 BAR SF 3:1

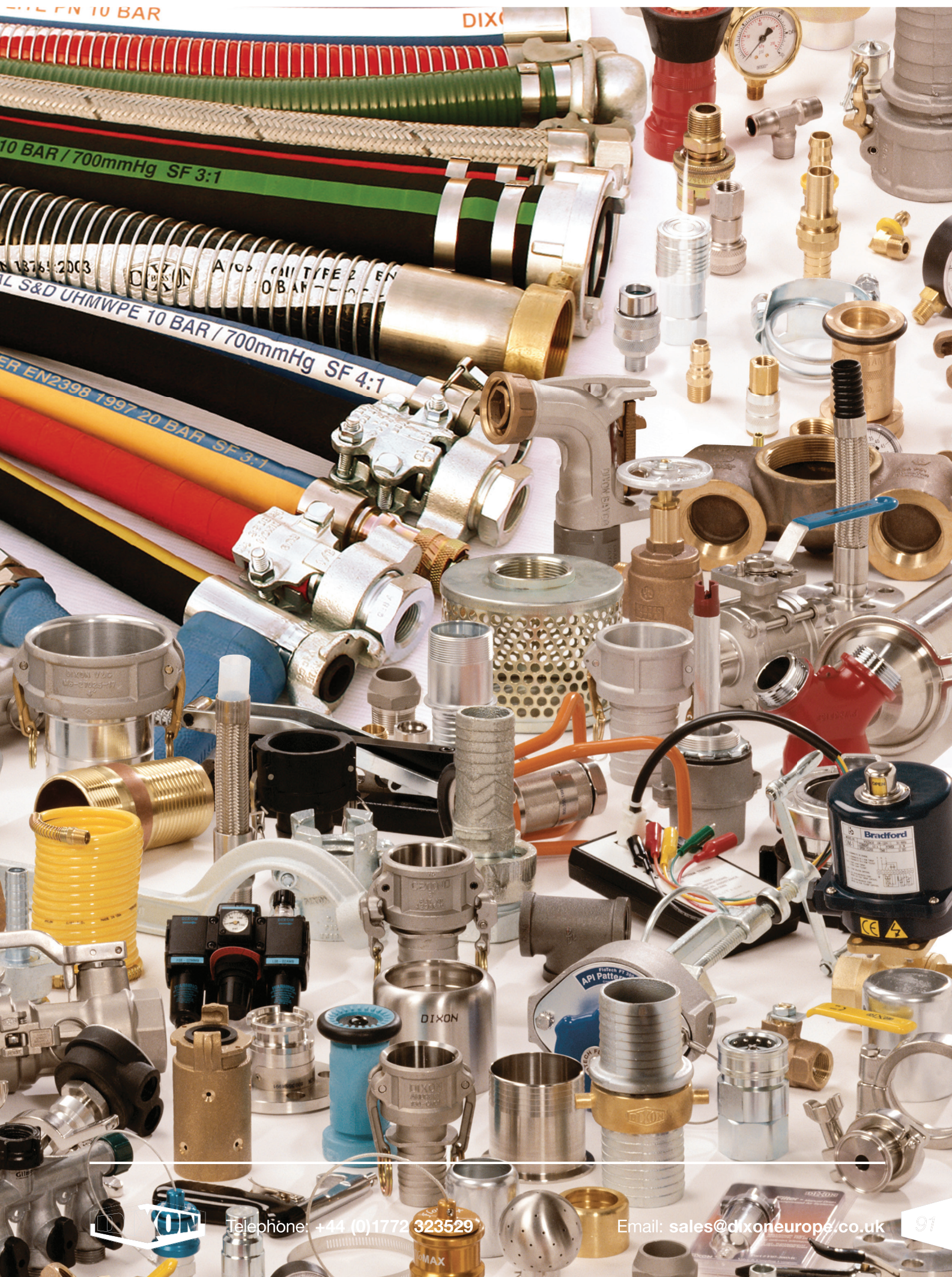

<b>A</b>	<b>AG Series</b>	page <b>18</b>
<b>B</b>	<b>Blowout</b>	page <b>42</b>
<b>C</b>	<b>BR Series</b>	page <b>71</b>
<b>D</b>	<b>CJ Series</b>	page <b>76</b>
<b>E</b>	<b>CVW Series</b>	page <b>59</b>
<b>F</b>	<b>DF Series</b>	page <b>65</b>
<b>G</b>	<b>Dry Disconnect</b>	page <b>87</b>
<b>H</b>	<b>H Series</b>	page <b>61</b>
<b>I</b>	<b>EA Series</b>	page <b>64</b>
<b>J</b>	<b>H Series</b>	page <b>7</b>
<b>K</b>	<b>H Series ISO B</b>	page <b>12</b>
<b>L</b>	<b>HS Series</b>	page <b>13</b>
<b>M</b>	<b>HT Series</b>	page <b>29</b>
<b>N</b>	<b>HTE Series</b>	page <b>33</b>
<b>O</b>	<b>J Series</b>	page <b>73</b>
<b>P</b>	<b>K Series</b>	page <b>15</b>
<b>Q</b>	<b>N Series</b>	page <b>78</b>
<b>R</b>	<b>P Series</b>	page <b>84</b>
<b>S</b>	<b>PD Series</b>	page <b>49</b>
<b>T</b>	<b>ST Series</b>	page <b>35</b>
<b>U</b>	<b>T Series</b>	page <b>57</b>
<b>V</b>	<b>TR Series</b>	page <b>23</b>
<b>W</b>	<b>V Series</b>	page <b>50</b>
<b>X</b>	<b>VEP Series</b>	page <b>21</b>
<b>Y</b>	<b>W Series</b>	page <b>25</b>
<b>Z</b>	<b>WS Series</b>	page <b>39</b>

## Dixon Europe

**Dixon Deutschland GmbH**  
Godesberger Strasse 20b  
D – 53842 Troisdorf – Spich  
Germany  
Tel: +49 (0)2241 844 060  
Email: info@dixon-deutschland.de

**Dixon Russia**  
22/2 A Sadovaya Street  
Office 27-H  
Saint Petersburg  
Russia  
Tel: +7 (812) 448-83-67  
Email: info@dixonrussia.ru

**Dixon Middle East**  
Executive Suite,  
PO Box 121599,  
Saif Zone-Sharjah,  
United Arab Emirates  
Email: enquiries@dixonme.com

**Dixon France**  
105 Route Pommiers  
UBIDOCA Center, 5837  
F-74370 Saint Martin Bellevue  
France  
Email: enquiries@dixoneurope.eu

## Dixon Worldwide

**Dixon Valve & Coupling Co**  
800 High Street  
Chestertown  
MD 21620  
USA  
Tel: +1 410 778 2000  
Email: sales@dixonvalve.com

**Dixon Asia Pacific**  
PO Box 2491  
Regency Park  
SA 5942  
Australia  
Tel: +61 8 8202 6000  
Email: enquiries@dixonvalve.com.au

**Dixon Shanghai**  
Room 801-803  
No.3553 North Zhongshan Rd  
Putuo District  
Shanghai, China  
Tel: +86 21 6173 7998  
Email: enquiries@dixonvalve.com.cn

**Dixon India**  
90, Virwani Industrial Estate,  
Western Express Highway,  
Goregaon East,  
Mumbai – 400 063, India  
Tel - +91-22-61949494 / 29271152  
Email: salesindia@dixonvalve.com.au



*The Right Connection®*

### Dixon Group Europe Limited

Dixon House, 350 Leach Place,  
Walton Summit Centre, Preston PR5 8AS, UK.

Telephone: +44 (0)1772 323 529

Fax: +44 (0)1772 314 664

Email: enquiries@dixoneurope.co.uk

[www.dixoneurope.co.uk](http://www.dixoneurope.co.uk) / [www.dixoneurope.eu](http://www.dixoneurope.eu)

Stay connected with Dixon on or   
[www.youtube.com/user/DixonValve](http://www.youtube.com/user/DixonValve)



**Customer Service:**  
**+44 (0)1772 323 529**