



# Table of Contents

## *Holedall™ Concept*

- 1      **Specifications**
- 2      **1¼" through 4" Standard and Long Holedall™ Swaged Couplings**
- 3      **1¼" through 4" Standard and Long Flanged Holedall™ Swaged Couplings using Collar with Jack Screws**
- 4      **RSTxxxNOS Stems with GASxxxxNOS Ferrules**
- 5      **Cam and Groove Holedall™ Couplings**
- 6      **Boss Ground Joint Holedall™ Couplings**
- 7      **Converting from Swaging to Internal Expansion**
- 8      **Internal Expansion of Steel and Stainless Steel couplings**
- 9      **Internal Expansion of H520 couplings**
- 10     **Parts List and Attachments**

# The Concept of the Holedall™ Coupling Applied with the Ram

The application of Holedall™ couplings to hose is best described as a draw type progressive swage. This swaging of the coupling to the hose is accomplished by pushing the tubular ferrule (normally made of tubular steel, but also available in brass or stainless steel) through a split die which reduces the ferrule O.D. causing the ferrule to penetrate into the hose wall. This results in a 360° uninterrupted compression band around the hose.

The Holedall™ coupling includes a hose stem and a ferrule. The hose stem is of a conventional serrated design, including a collar which locks the ferrule to the stem. The tubular ferrule will include a top row of holes and a series of serrations (if present, depending upon style) inside. The purpose or design function of the holes and serrations (if present, depending upon style) is as follows:

1. Upon insertion of the stem into the hose, prior to the swage, the top row of holes affords positive proof, attained by visual inspection, that the stem portion of the coupling is fully inserted into the hose.
2. The ferrule holes and serrations provide additional holding power to the coupling.  
This is effected as follows:

The Holedall™ coupling is applied directly to the raw end of the hose without, in any manner, altering the hose cover. The hose cover need not be skived or buffed off. However, since the rubber content of the hose wall under the strong compression band of the swaged ferrule tends to be displaced (rubber is not compressible), it is therefore necessary to provide an escape area for this displacement. The ferrule holes provide a portion of this and thus permit a tighter compression band. At the same time, we use this rubber displacement to enhance the holding power of the coupling. The serrations (if present depending upon style) are located under the compression band (swaged area) of the ferrule and act as "teeth" biting into the hose cover.

3. Upon completion of the swage, the holes serve still another function. By visual inspection of the coupling, the holes provide an indication of the adequacy of the swage. Rubber will normally flow into the holes in the top reservoir area. The reservoir area should fill up (except when hose wall thickness is below 5/16").

The contour or swaged form of the Holedall™ coupling provides additional holding power (coupling retention).

The design of the ram swaging dies effect a swaged form to the Holedall™ coupling in which it should be noted that the ferrule is not swaged its entire length. With the draw type progressive swage, the Holedall™ coupling utilizes a planned forward cold flow of the rubber content of the hose wall into the reservoir area of the coupling. The hose wall, which is confined between the coupling stem and the tubular ferrule, should (with our type swage) only move forward. As this occurs, the hose wall tends to slightly thin out in the area of the swage and to become heavier in the forward reservoir area. Thus, when a Holedall™ coupling is swaged onto a hose much of the same result is accomplished that is effected when one slides a nut onto a section of rigid tubing and then flares the tubing. The nut cannot slide past the flared end of tubing and likewise the Holedall™ coupling cannot slide past the flared hose end.

The die reduction, which effects the penetration of the ferrule into the hose wall, may vary with hose wall construction. A Holedall™ coupling may be applied to almost any type of hose construction style with excellent results. The degree of die reduction or subsequent ferrule penetration into the hose wall is dependent upon a number of variable conditions, including the compound nature and thickness of the tube, the compound nature and thickness of the cover stock, and the material and construction design of the reinforcing members. Desirable range of the ferrule penetration into the hose wall is normally 18% - 24% of the hose wall thickness, but it will vary with the construction of the hose wall. In order to effect the proper ferrule penetration into the hose wall and to provide compression band to withstand the hoop stress, it is necessary to increase the gauge or thickness of the ferrule wall. Generally as the hose wall thickens and hose size increases, the ferrule is made with an increased wall thickness.

Listed below are a few guidelines for correct swaging procedures:

1. Always measure (with a diameter tape) the hose free O.D. Both ends of the hose must be measured. Free O.D. is outside diameter before stem is inserted.
2. For hoses having a wall thickness of 5/16" or greater, chamfer hose tube at 45° angle by 1/8" wide. This is done prior to stem insertion and will help eliminate the hose end from flaring when the stem is fully inserted.
3. Select the correct ferrule from the die and ferrule chart by using the combination of hose I.D. and free O.D. Ferrule must be able to slip over stem and hose without removing (skiving or buffing) hose cover.
4. Select a die (from die and ferrule chart) based upon the free O.D. measured for the end to be swaged to effect a 18% to 24% reduction.
5. For standard length stems and ferrules, swage is complete when the pusher face meets the die face. For long length stems and ferrules, effect as long a swage as possible. (See footnote on next page)
6. Apply a high viscosity lubricant (grease or oil) to ferrule O.D. and die I.D. before initiating swage. Crisco® works best for most swaging procedures.
7. Inspect (visually) the completed swage of coupling, both external and internal where possible.

Troubleshooting: Listed below are some troubles that may occur and their causes:

Trouble	Causes
Ferrule cracks	1. Too small a ferrule size
	2. Too small a die selection
Hose cover bulge behind ferrule	1. Too small a ferrule size
	2. Too small a die selection
Hose tube bulge (internal bulge)	1. Too small a ferrule size
	2. Too small a die selection
Ferrule bulges or collapses at top portion	1. Too small a ferrule size
	2. Too small a die selection
	3. Length of swage too long
	4. Ferrule and stem not in proper position when swage was initiated
Buckling or collapsing of coupling stem	1. Too small a ferrule size
	2. Too small a die selection

Trouble may occur which is related to the hose design and manufacture. For good coupling application and performance, it is essential that hose manufacturers be concerned with the requirements for good coupling retention. Tensile strength, elasticity, durometer hardness, cold flow characteristics and adhesion of hose components all effect coupling performance.

## Footnote

The normal swage length, for standard length stems and ferrules, is obtained by terminating the swage when the top holes completely pass into the lead portion of the die. In other words, when the face of the pusher meets or touches the face of the die, the swage is complete. When using long length stems and ferrules, it may be necessary to terminate the swage sooner. If rubber starts to extrude out of the top holes or the top (reservoir area) of the ferrule begins to swell before the normal swage length is effected, stop the swage.

The Ram pressure gauge provides another guide for correct swaging procedures. All Rams are equipped with pressure gauges. These gauges provide a line pressure reading in PSI (Pounds per Square Inch). For example:the 100 Ton Ram includes an electric motor driven hydraulic pump capable of developing 10,000 PSI. The area of the piston head of the ram cylinder is 20.6 square inches. Thus, our maximum ram force is 10,000 x 20.6 or 206,000 pounds, which is equivalent to approximately 100 tons.

All hoses of one size and style should require approximately the same ram force for swaging. However, since the Ram is intended for use with a variety of hoses of varying constructions and hose wall thickness, we therefore cannot provide a chart of recommended pressure gauge readings. Dixon strongly recommends the recording of data such as hose type, I.D. size, O.D. measurement for each end, ferrule used each end, die used each end and pressure (PSI) required to effect the swage on each end. The Ram user, with this database and his/her experience, will consistently produce quality hose assemblies.

## General Guidelines

1. This manual supersedes all previous instructions for the 100 Ton Ram.
2. Operator(s) should wear safety apparel such as safety glasses and steel toe shoes when operating this equipment.
3. The Holedall™ Coupling System and the procedures in this manual are an engineered system. Skipping or eliminating steps in the procedure, unless directed to do so, can lead to an assembly failure.
4. Do not "mix and match" stems, ferrules and accessories from manufacturers other than Dixon.
5. After assembly is complete, pressure test the assembly in accordance with Association of Rubber Products Manufacturers (ARPM) specifications.
6. For questions or assistance, please call Dixon at 1-877-963-4966.

The information contained in this manual applies to couplings engineered and produced by Dixon for permanent attachment to hoses. It is to be used only as a guide and does not address special, unusual, unique or non-standard coupling applications. If you have any questions regarding any application, please call Dixon at 1-877-963-4966.





*The Right Connection®*

## *Section 1*

### **100 Ton Ram**

### **Specifications**

Dixon  
800 High Street • Chestertown, MD 21620  
ph: 877.863.4966 fax: 800.283.4966  
[dixonvalve.com](http://dixonvalve.com)

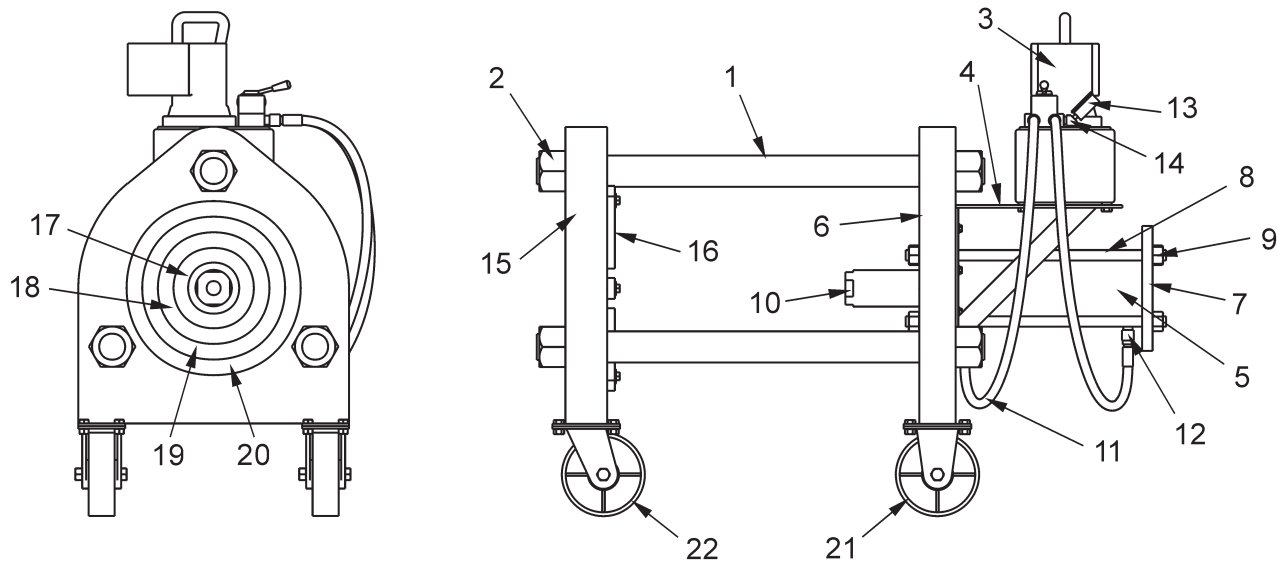

Item	Part #	Description	Qty
1	<b>001-0003</b>	Tie rod	3
2	<b>001-0004</b>	Tie rod hex nut	6
3	<b>001-0008</b>	Hydraulic pump	1
4	<b>001-0011</b>	Hydraulic pump support	1
5	<b>001-0052</b>	Hydraulic cylinder	1
6	<b>001-0053</b>	Cylinder end plate	1
7	<b>001-0017</b>	Cylinder backing plate	1
8	<b>001-0016</b>	Cylinder tie rod	4
9	<b>001-0005</b>	Cylinder tie rod nut	8
10	<b>0010-064</b>	Rod cap	1
11	<b>001-0019</b>	Hydraulic hose with hydraulic couplings	2
12	<b>31-300</b>	Hydraulic quick connect npt plug	2
13	<b>GLSS10000</b>	0-10,000 PSI liquid filled gauge	1
14	<b>001-0024</b>	Gauge adapter	1
15	<b>001-0001</b>	Die bed plate	1
16	<b>0010-154</b>	Die retainer strap	6
17	<b>M012-001</b>	9" Die carrier	1
18	<b>M012-002</b>	12" Die carrier	1
19	<b>M012-003</b>	15" Die carrier	1
20	<b>M012-004</b>	18" Die carrier	1
21	<b>001-0009</b>	Steel wheel (rigid)	2
22	<b>001-0010</b>	Steel wheel (swivel)	2



## Specifications

Net Weight	1,900 lbs. basic equipment only
Crated Weight	2,100 lbs.
Dimensions	60" long x 26" wide x 48" high
Crated Dimension	76" long x 40" wide x 48" high
Pump Motor	Power Team PE554 1½ H.P. Universal Motor; 12,000 RPM; 115V single phase, 60/50 cycle AC (not dual voltage); 25 Amp, lightweight "handle-top" housing
Motor Control	"Run-Off-Remote" motor control switch; 25 Amp motor control relay cavity mounted in motor housing; hand held remote switch
Safety Valves	Relief valve set at 10,000 PSI
Control Valve	Built-in manually operated 4-way control valves with ¾" NPT port
Gauge	Calibrated 0-10,000 PSI
Reservoir	Convenient mounting holes in base
Oil Delivery	650 cu. in/min. at 100 PSI 80 cu. in/min. at 1,000 PSI 70 cu. in/min. at 5,000 PSI 55 cu. in/min. at 10,000 PSI

Note: 2-stage pump provides fast, no load approach speed and then shifts into slow actuation as the load is applied.

- Ram double acting (Power Team RD10013)
- 13⅞" stroke
- 103.1 tons of push at 10,000 PSI
- 44.2 tons of pull at 10,000 PSI

---

## Preparations

Filling the Reservoir	Before removing the filler plug, clean the area around the plug. The pump is a precision built unit, special care should be taken to preclude foreign particles from entering the reservoir. With cylinder fully retracted, fill the tank 1" to 1½" from the top. Replace the filler plug.
Approved Hydraulic Oils	Power Team 9637 Mobile DTE25 or equivalent
Available Motor Variations	220-440, etc. Also 1½ H.P. and 3 H.P.
Reservoir Variations	5 gallon or 10 gallon reservoir available

The standard 1½ H.P., 12,000 RPM, 115 volt motor and the 2½ gallon reservoir has proven highly successful. Dixon feels it is the best design, and variations are not desirable.

## Operating Controls

- F-N-R (Forward-Neutral-Reverse) directional control lever.

The F-N-R lever (shown in the neutral position) controls the direction of the ram cylinder. To extend the cylinder (forward) in the direction of the die bed, move the lever toward the pump motor then activate the pump. To retract the cylinder (reverse), move the lever away from the pump motor then activate the pump.

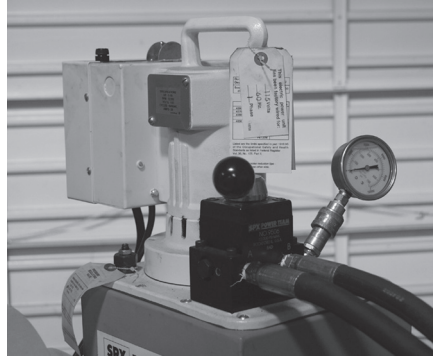

- On-Off-Remote switch, 0 - 10,000 PSI pressure gage and hand held remote.

When the toggle switch is placed in the "On" position, the pump motor will run until the toggle switch is placed in the "Off" position. When the toggle switch is placed in the "Remote" position, the hand held remote is activated. To run the pump motor, depress and hold the switch on the remote. To stop the motor, release the switch on the remote. For practical purposes, leave the toggle switch in the "Remote" position. All future references to activating the pump motor should be understood that the hand held remote is being used.

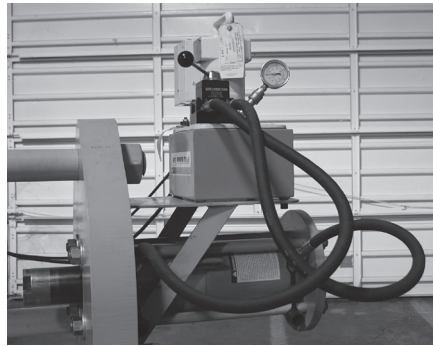

Caution! Never dead-end the cylinder (fully extended or fully retracted) and leave it with pressure showing on the gage. If the cylinder is dead-ended, always move the lever to the neutral position after stopping the pump. Failure to do so can shorten the life of the cylinder seals.





The Right Connection®

*Section 2*

**100 Ton Ram Operating Instructions  
for  
1¼" through 4" Standard & Long  
Holedall™ Swaged Couplings**

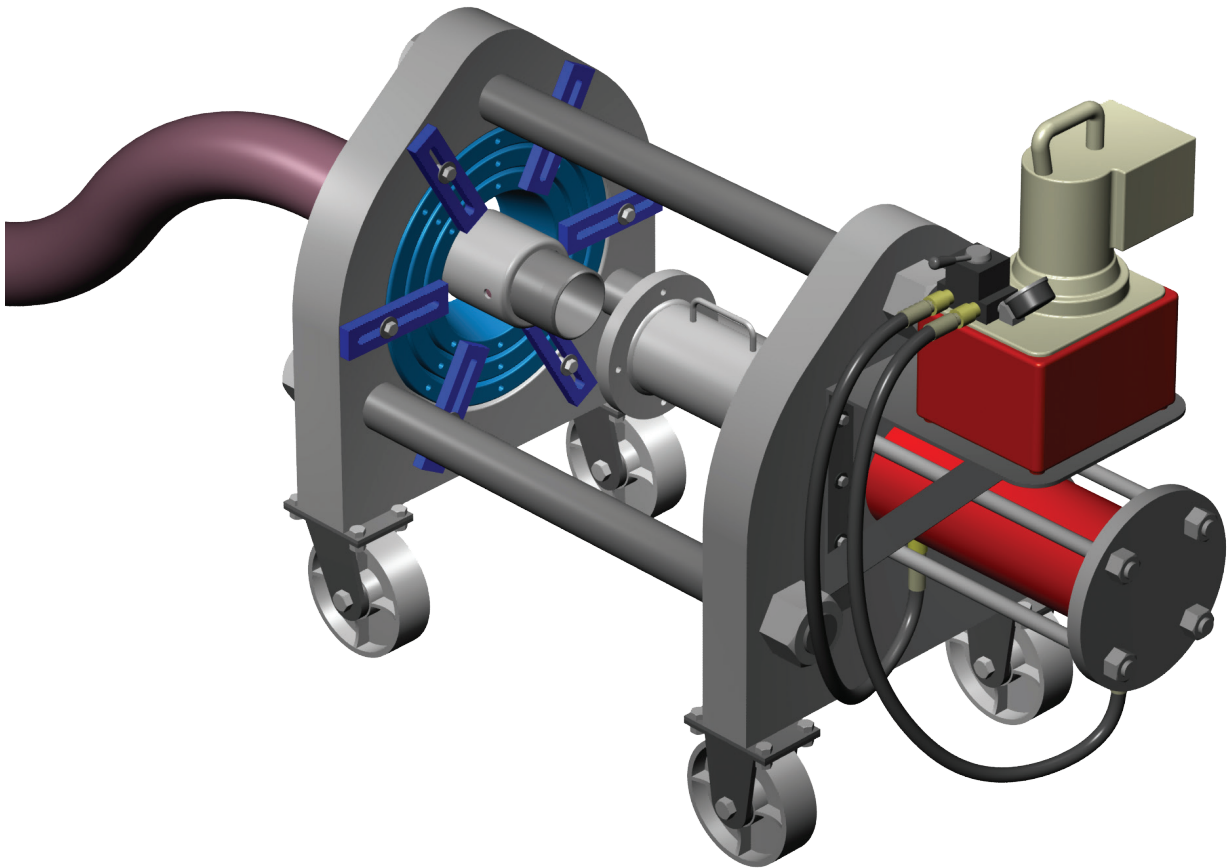

Dixon

800 High Street • Chestertown, MD 21620

ph: 877.863.4966 fax: 800.283.4966

[dixonvalve.com](http://dixonvalve.com)

## 1a

Install the 4" main pusher (**M011-065**) by sliding it onto the rod cap of the ram cylinder. Make sure that the pusher is all the way on the rod cap.

For 1¼" - 3" couplings proceed to Step 1b.  
For 4" couplings, proceed to Step 2.

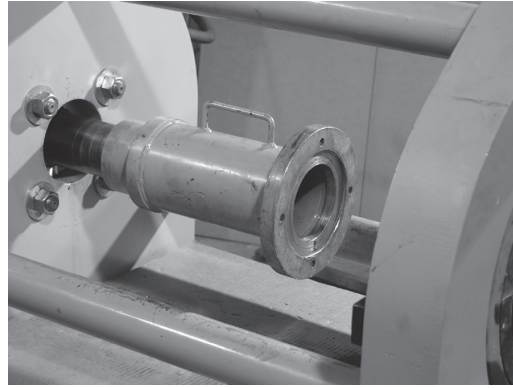

## 1b

For 1¼" - 3" couplings insert the appropriate size adapter pusher into the 4" main pusher (**M011-065**).

Shown here is the 2" adapter pusher (**M011-115**) being inserted.

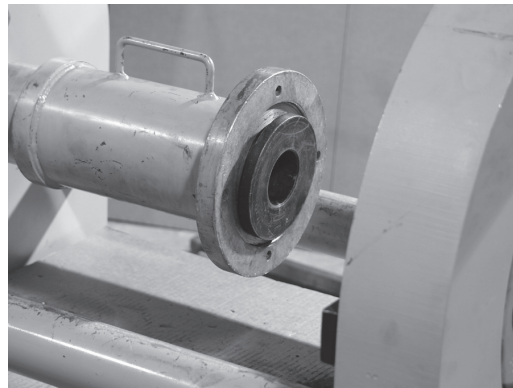

## 2

Install the required die holders ensuring that the seams between the die holder halves do not line up. The die holders are designed to fit one inside the other.

A guideline for selecting die holders is:

M012-001 1¼" - 3" I.D. hose

M012-002 4" - 6" I.D. hose

**Caution!** Never use a swaging die as a die holder! 

Secure the die holders with tie down bars to prevent the die holders from slipping out of the die bed unexpectedly.

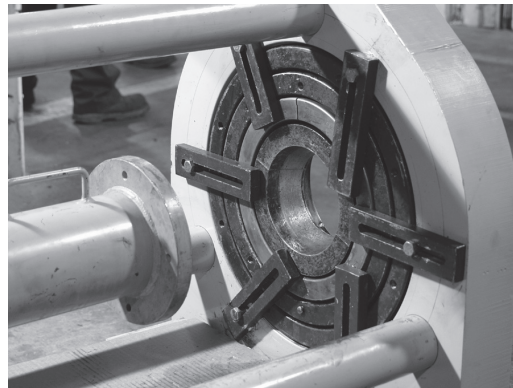

## 3

Accurately measure the hose O.D. with a diameter tape. Each end of the hose should be measured to guarantee the correct ferrule and die selection. Select the correct ferrule and die based upon the hose free O.D. just measured from the die chart.



4



Assuring that the hose end is cut square, chamfer the I.D. of the hose  $\frac{1}{8}$ " at a 45° angle. This will aid in stem insertion. If the hose is to be static grounded, follow hose manufacturers procedure for proper static grounding.

5



Lubricate the I.D. of the hose and the O.D. of the stem with Dixon Coupling Lubricant or equivalent. Insert the stem all the way into the hose until the ring on the stem comes in contact with the end of the hose.

6

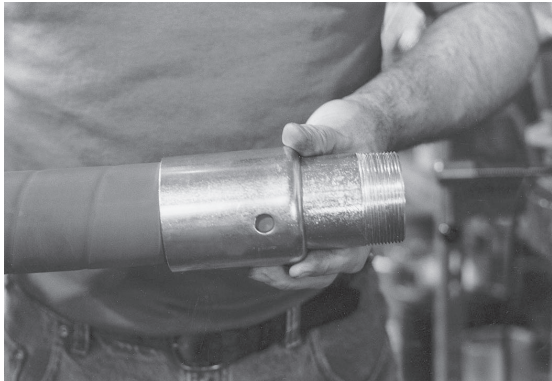

Slide the ferrule over the stem and over the O.D. of the hose until the turned over portion of the ferrule rests on the ring of the stem.

7a

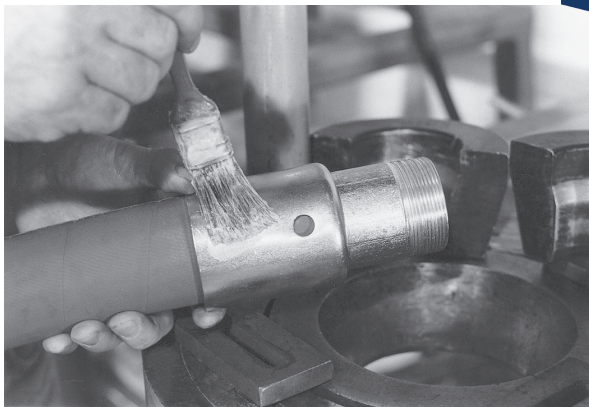

Lubricate the outside of the ferrule with Crisco® (recommended) or high viscosity oil or heavy duty grease.

7b

Lubricate the I.D. of both die halves with Crisco® (recommended) or high viscosity oil or heavy duty grease.



8

Bring the hose with the stem and ferrule through the die bed. Insert the stem into the pusher so that the ferrule contacts the pusher. Make sure that there is sufficient room between the die holders and the end of the ferrule to comfortably insert the die halves into the die holders.

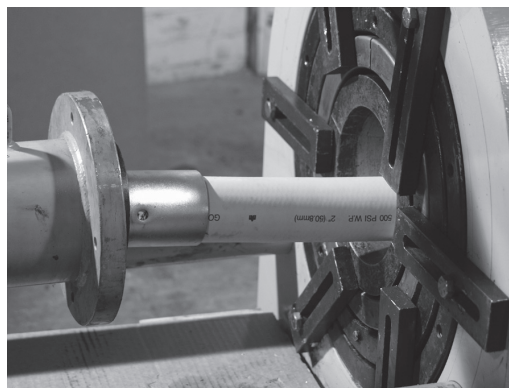

9

Lifting up the hose, insert one die half under the hose. Lower the hose so that it rests on the die. Insert the other die half. Make sure that the seams of the die do not line up with the seams on the die holders.



10

Continue to jog the cylinder until pressure begins to register on the gauge. Leave the directional control lever in the "FORWARD" position. Loosen the bolt on the tie down bar that is holding the die in place. Move the tie down bar so that the entire flange on the pusher will clear. Move any other tie down bars that may interfere with the pusher. When the pusher contacts the die release the pressure. Important! Inspect the position of the stem and ferrule with the pusher. Make sure the collar (ring) on the stem is in contact with the ferrule before proceeding.

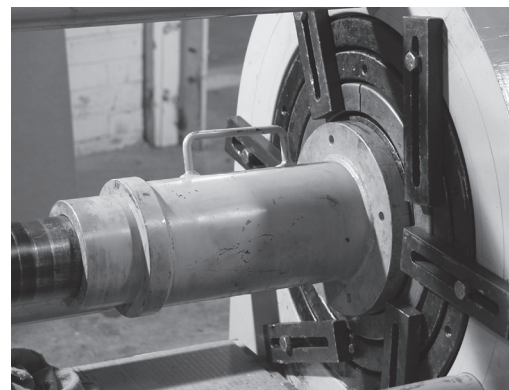

11

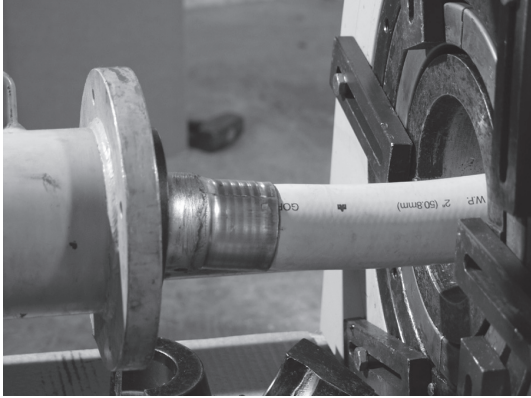

Move the directional control lever to the "REVERSE" position and depress the button on the remote. Retract the cylinder far enough (approximately 1") to allow a tie down bar be placed so that the die does not come out of the die holder. Secure the tie down bar by tightening the bolt. Continue retracting the cylinder until there is sufficient room for the stem and ferrule to clear the die bed.

12a



Position a rubber sheet or pad under the die bed. While holding the die in place with one hand, loosen the bolt on the tie down bar and move the tie down bar so that it clears the die. Slowly slide the hose towards the pusher. When the die clears the die holder, one or both halves may fall to the floor. If one half remains on the ferrule, tap it with a mallet until it releases. If both halves remain on the ferrule, it may require the halves be pried apart at the seam.

12b

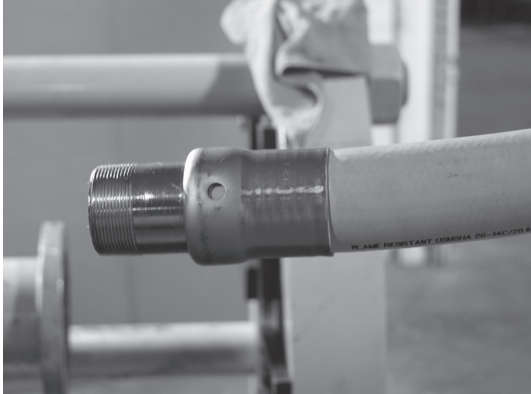

Lifting up the hose, insert one die half under the hose. Lower the hose so that it rests on the die. Insert the other die half. Make sure that the seams of the die do not line up with the seams on the die holders.







The Right Connection®

### *Section 3*

## **100 Ton Ram Operating Instructions for 1¼" through 4" Standard & Long Flanged Holedall™ Swaged Couplings Using Collar with Jack Screws**

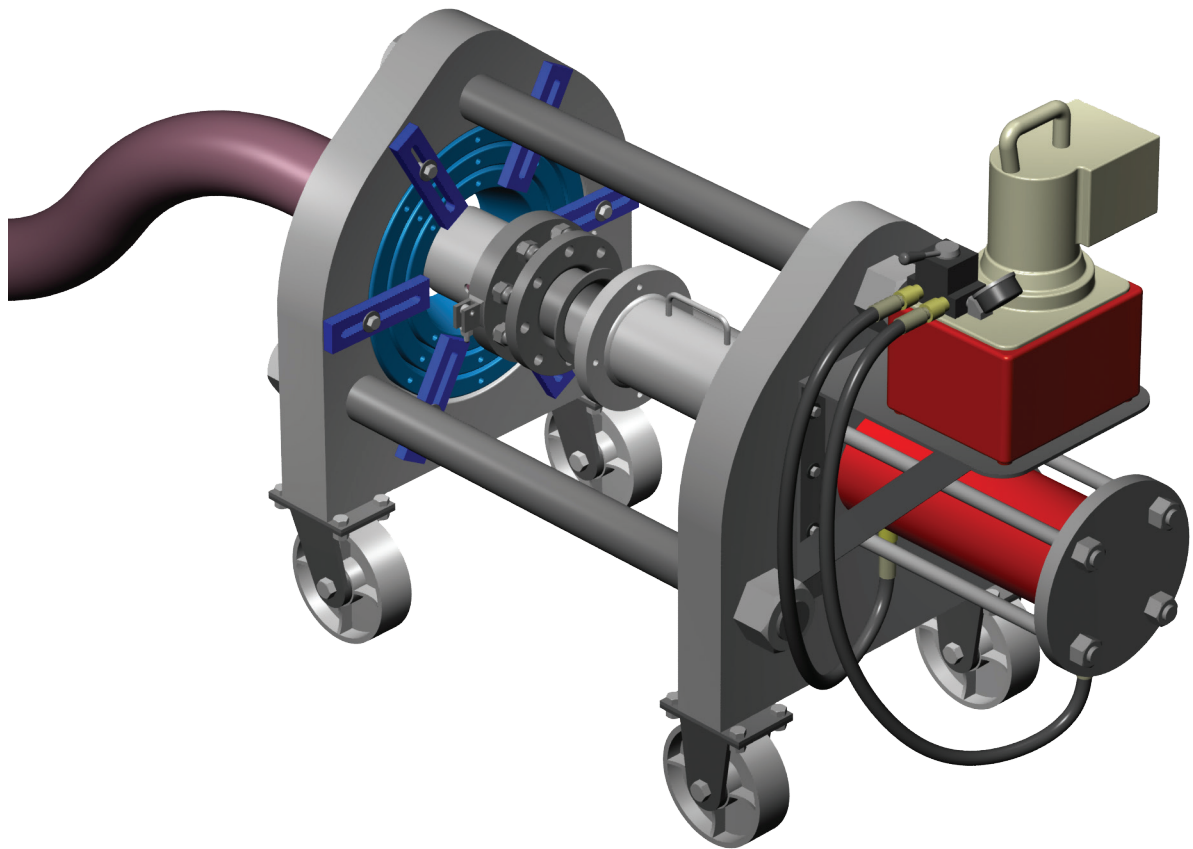

Dixon  
800 High Street • Chestertown, MD 21620  
ph: 877.863.4966 fax: 800.283.4966  
[dixonvalve.com](http://dixonvalve.com)

**!** Any coupling assembly (welding of stem, stub end, flange, etc.) must be done prior to starting this procedure. Failure to do so (i.e. welding flange to stem after the swage) can result in serious structural damage to the hose and premature assembly failure.

**1a**

Install the 4" main pusher (**M011-065**) by sliding it onto the rod cap of the ram cylinder. Make sure that the pusher is all the way on the rod cap.

For 1¼" - 3" couplings proceed to Step 1b.  
For 4" couplings, proceed to Step 2.

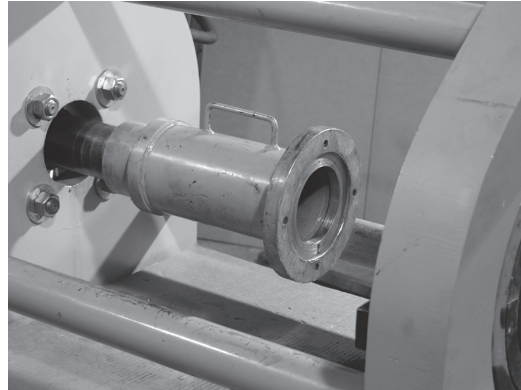

**1b**

For 1¼" - 3" couplings insert the appropriate size adapter pusher into the 4" main pusher (**M011-065**).

For example:  
Shown here is the 2" adapter pusher (**M011-113**) being inserted.

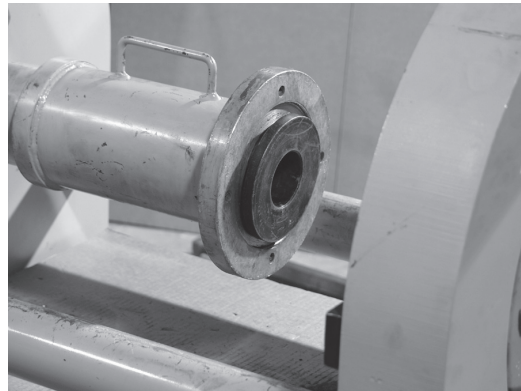

**2**

Accurately measure the hose O.D. with a diameter tape. Each end of the hose should be measured to guarantee the correct ferrule and die selection. Select the correct ferrule and die based upon the hose free O.D. just measured from the die chart.

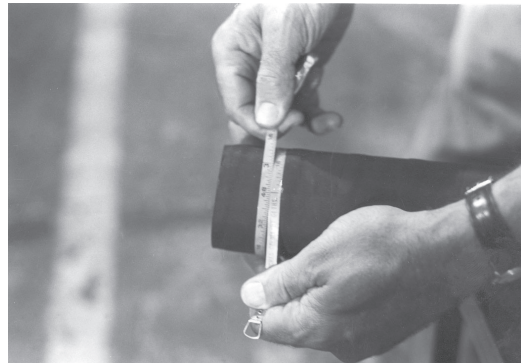

4



Assuring that the hose end is cut square, chamfer the I.D. of the hose  $\frac{1}{8}$ " at a 45° angle. This will aid in stem insertion. If the hose is to be static grounded, follow hose manufacturers procedure for proper static grounding.

5



Lubricate the I.D. of the hose and the O.D. of the stem with Dixon Coupling Lubricant or equivalent. Insert the stem into the hose until the hose end contacts the stem collar. Position the sight hole on the ferrule so that this can be observed. After stem insertion, slide the ferrule down until the turned-over part of the ferrule contacts the stem collar.

6

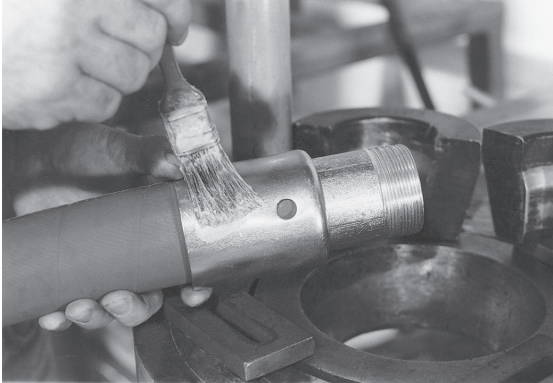

Lubricate the outside of the ferrule with Crisco® (recommended) or high viscosity oil or heavy duty grease.

7a



Lubricate the I.D. of both die halves with Crisco® (recommended) or high viscosity oil or heavy duty grease.

## 6a

Install the required die holders ensuring that the seams between the die holder halves do not line up. The die holders are designed to fit one inside the other.

A guideline for selecting die holders is:

**M012-001** 1¼" - 3" I.D. hose

**M012-002** 4" - 6" I.D. hose

**Caution!** Never use a swaging die as a die holder! 

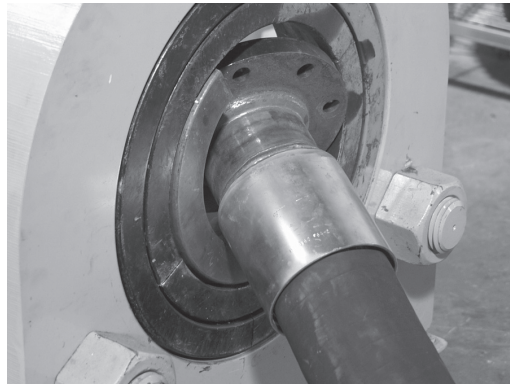

## 6b

Secure the die holders with tie down bars to prevent the die holders from slipping out of the die bed unexpectedly.

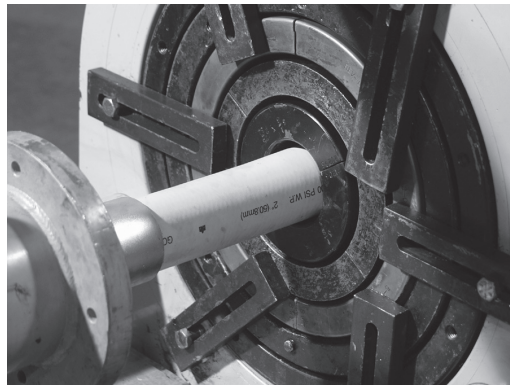

## 7

Bring the hose with the stem and ferrule through the die bed. Insert the stem into the pusher so that the ferrule contacts the pusher. Make sure that there is sufficient room between the die holders and the end of the ferrule to comfortably insert the die halves into the die holders.

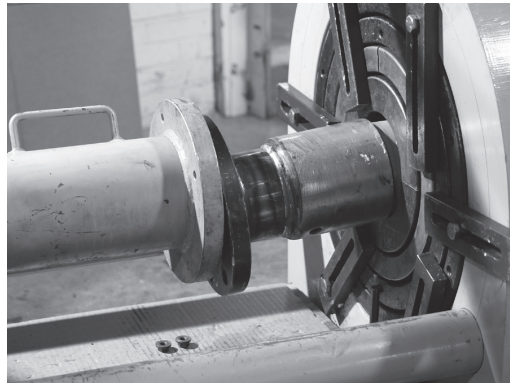

## 8a

Ensuring that all of the jackscrews have been threaded completely into the collar, install the collar with jackscrews between the ferrule and the flange. Position it so that the flat side of the collar is next to the ferrule and the jackscrews are closest to the flange lining up with the bolt holes. Secure both collar halves with the "T" bolt.

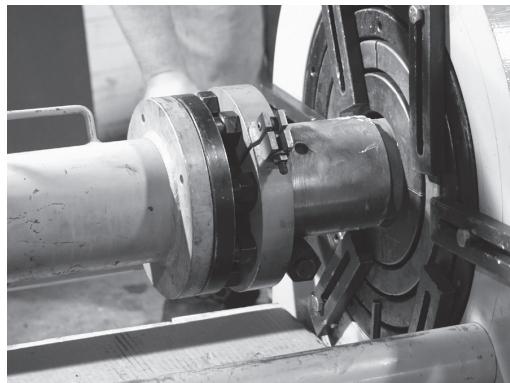

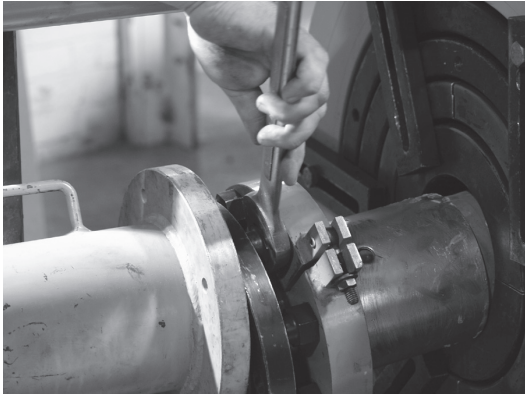
**8b**

Extend all of the jackscrews so that they are contacting the flange. With a wrench, tighten one jackscrew one half turn. Moving to the jackscrew opposite of the one just tightened, tighten it one half turn. Moving to the jackscrew immediately to the right of the first one tightened, tighten it one half turn. Moving to the jackscrew opposite of the one just tightened, tighten it one half turn. Keep repeating this process until all jackscrews are evenly tensioned.

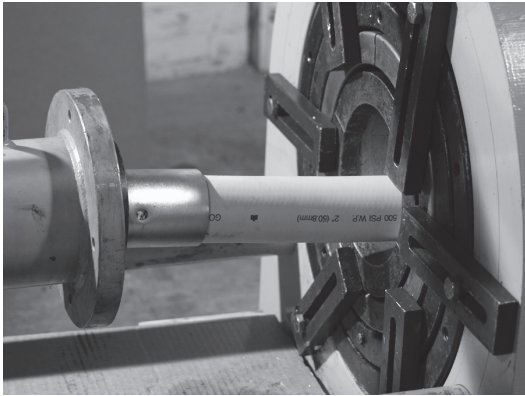
**9a**

Lifting up the hose, insert one die half under the hose. Lower the hose so that it rests on the die. Insert the other die half. Make sure that the seams of the die do not line up with the seams on the die holders.

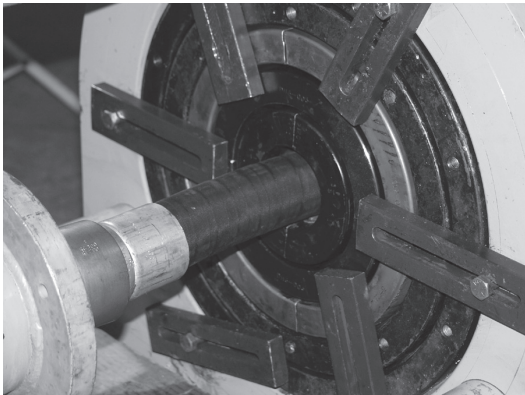
**9b**

While holding the die in place with one hand, place one of the tie down bars over the die so that it does not come out of the die holder unexpectedly. Secure the tie down bar by tightening the bolt.

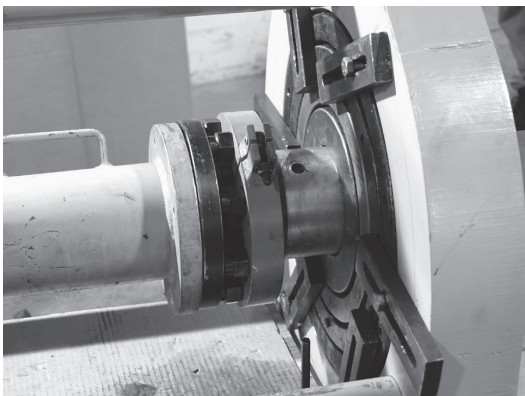
**10a**

Move the directional control lever to the "Forward" position and depress the button on the remote. Advance the cylinder forward until the end of the ferrule is near the die opening. Using a wooden board or metal pipe, lift the ferrule up. Jog the cylinder by depressing and releasing the button on the remote. This will allow the ferrule to enter the die slowly. After the ferrule has entered the die, stop advancing the cylinder.

## 10b

Align the flange face with the pusher.

For 4" assemblies, the raised face on the flange will fit into the recess of the 4" Main Pusher (M011-065).

For 1½" - 3" assemblies ensure the flange face and the pusher are flush.

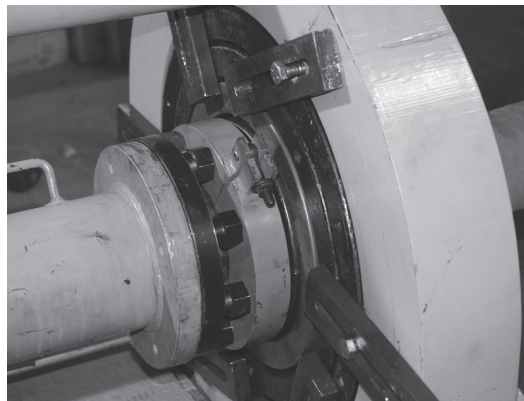

## 11a

Loosen the bolt on the tie down bar holding the die in place. Move the tie down bar so that it clears the collar. When this is done, snug the bolt on that tie down bar.

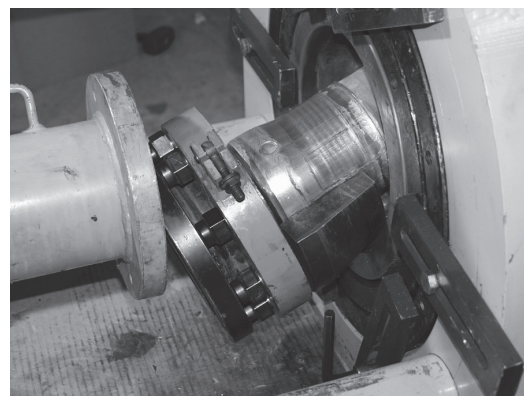

## 11b

Depress and hold the button on the remote until the top of the ferrule (where welded to stem) is even (flush) with the top of the die. Release the button. Return the directional control lever to the "NEUTRAL" position.

**Note:** If the gauge reads 10,000 PSI before swaging is complete, stop. The ferrule or die used for that hose end may be incorrect. Contact Dixon for further assistance.

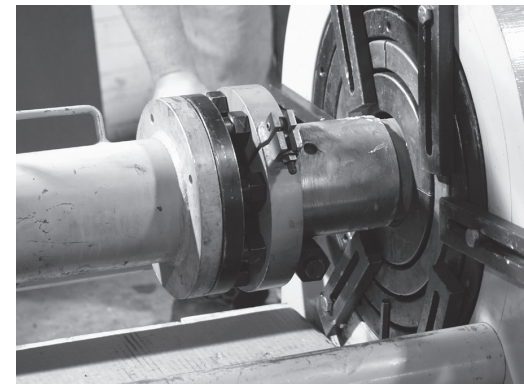

## 12

Loosen all of the jackscrews so that they clear the flange. Loosen the nut on the "T" bolt so that the "T" bolt moves easily out of its slot. Remove the collar from between the flange and the ferrule.

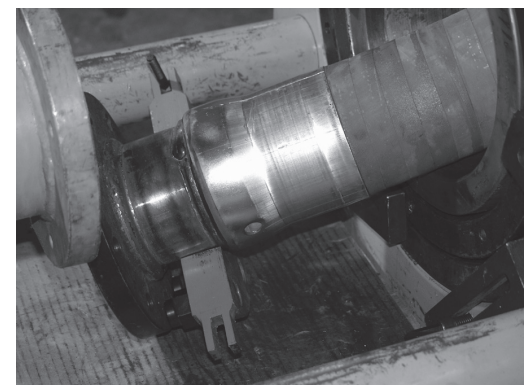

## 13a

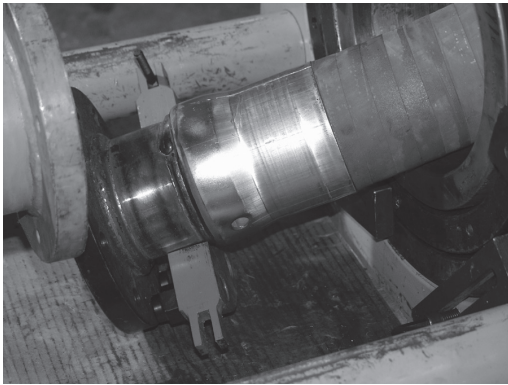

Position a rubber sheet or pad under the die bed. *Slowly* slide the hose towards the pusher. When the die clears the die holder, one or both halves may fall to the floor. If one half remains on the ferrule, tap it with a mallet until it releases. If both halves remain on the ferrule, it may require the halves be pried apart at the seam.

## 13b

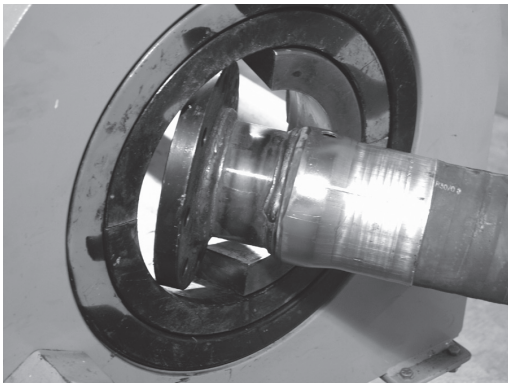

Loosen the bolt(s) on the tie down bar(s) and move the tie down bar(s) so that they clear one die bed spacer. Tighten any bolt just loosened. Remove the die bed spacer one half at a time. Repeat this process for each die bed spacer to be removed. Remove only enough die bed spacers to allow the flange to pass through.

## 13c



Wipe excess lubricant from hose and ferrule. Bring hose with stem and ferrule back through die bed.







The Right Connection®

*Section 4*

**100 Ton Ram Operating Instructions  
for  
RSTxxxNOS Stems  
with  
GASxxxxNOS Ferrules**

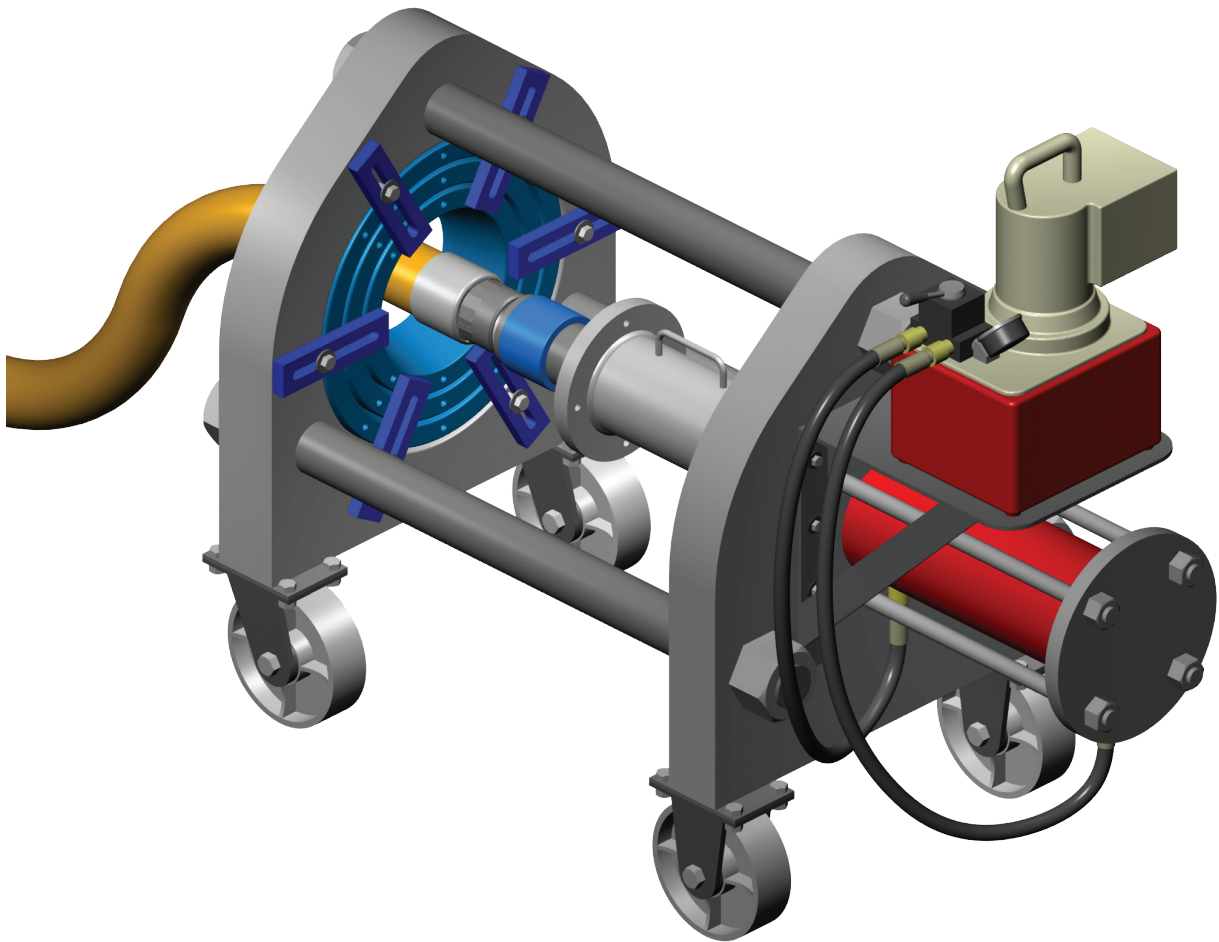

Dixon

800 High Street • Chestertown, MD 21620

ph: 877.863.4966 fax: 800.283.4966

[dixonvalve.com](http://dixonvalve.com)

1

Install the required die holders ensuring that the seams between the die holder halves do not line up. The die holders are designed to fit one inside the other.

A guideline for selecting die holders is:

**M012-001** 1¼" - 3" I.D. hose

**M012-002** 4" - 6" I.D. hose

**Caution!** Never use a swaging die as a die holder! 

Secure the die holders with tie down bars to prevent the die holders from slipping out of the die bed unexpectedly.

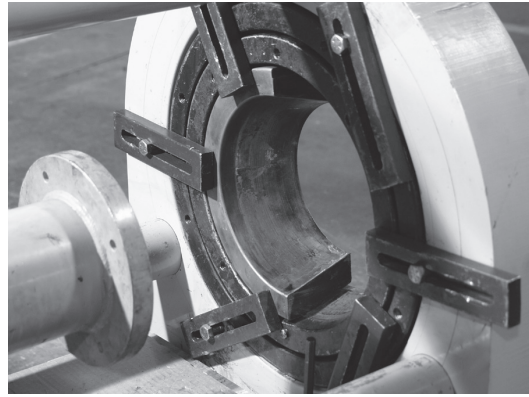

2

Install the 4" Main Pusher (**M011-065**) by sliding it onto the rod cam of the ram cylinder. Make sure that the pusher is all the way on the rod cap.

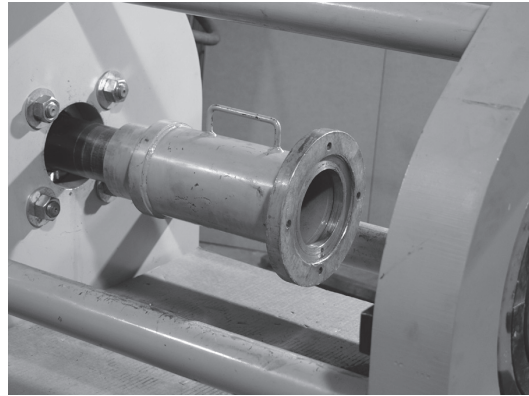

3

Accurately measure the hose O.D. with a diameter tape. Each end of the hose should be measured to guarantee the correct ferrule and die selection.

Select the correct ferrule and die based upon the hose free O.D. just measured from the die chart. Make sure the hose end is cut square. If the hose is to be static grounded, follow hose manufacturers procedure for proper static grounding.



4

Slide the ferrule all the way onto the hose. Place a mark on the hose at the end of the ferrule. Move the ferrule ⅛" from the mark just made towards the end of the hose. Place a second mark on the hose at the end of the ferrule.



5



Lubricate the O.D. of the stem and the I.D. of the hose with Dixon lubricant or equivalent. Insert the end of the fitting into the hose. Assemble the ferrule onto stem by sliding turned over portion of ferrule past notched section of stem collar. Rotate ferrule 90° (¼ turn). With ferrule and stem engaged, continue installing stem until ferrule reaches the second mark on the hose.

6



Lubricate the outside of the ferrule with Crisco® (recommended) or high viscosity oil or heavy duty grease.

7



Lubricate the I.D. of both die halves with Crisco® (recommended) or high viscosity oil or heavy duty grease.

8

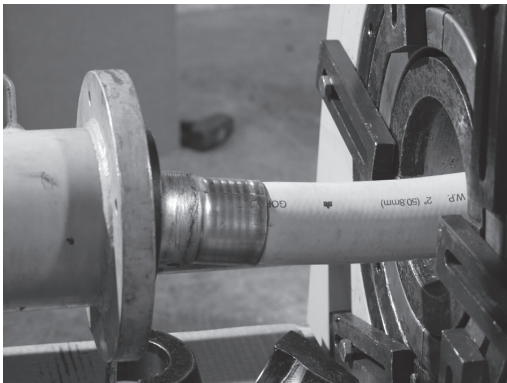

Lifting up the hose, insert one die half under the hose. Lower the hose so that it rests on the die. Insert the other die half. Make sure that the seams of the die do not line up with the seams on the die holders.

## 9

Install appropriate size spacer ring over the threads of the stem so that it contacts the ferrule. The spacer rings are listed as follows:

1½"	<b>RST150SPACE</b>
2"	<b>RST200SPACE</b>
3"	<b>RST300SPACE</b>



## 10

Insert the stem into the pusher so that the spacer ring just installed contacts the pusher.

1½"	<b>M011-112</b>
2"	<b>M011-113</b>
3"	<b>M011-115</b>

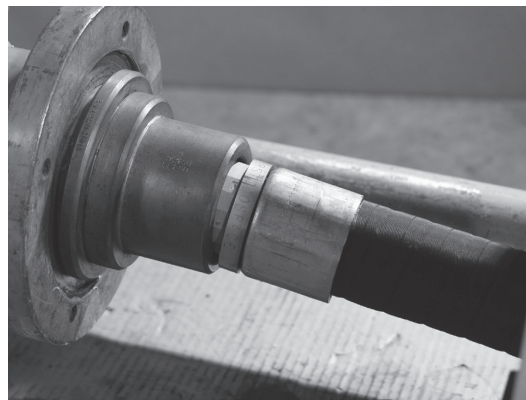

## 11

Put the directional control lever in the "FORWARD" position. Advance the cylinder forward until the end of the ferrule is near the die opening. Using a wooden board or metal pipe, lift the ferrule up. Jog the cylinder by depressing and releasing the button on the remote. This will allow the ferrule to enter the die slowly without contacting the die face.

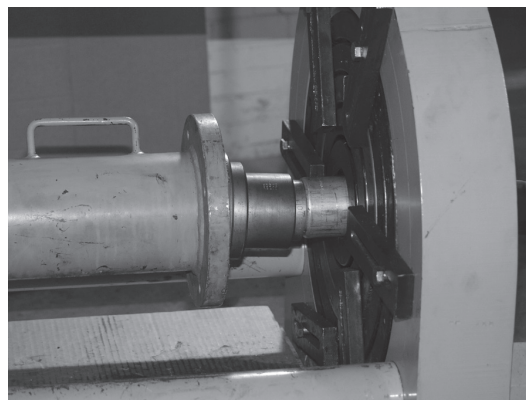

## 12

Depress and hold the button on the remote until the pusher meets the die face. When the extension contacts the die, release the button. Move the directional control lever to the "NEUTRAL" position. **Note:** The spacer ring will enter the die.

**Note:** If the gauge reads 10,000 PSI before swaging is complete, stop. The ferrule or die used for that hose end may be incorrect. Contact Dixon for further assistance.

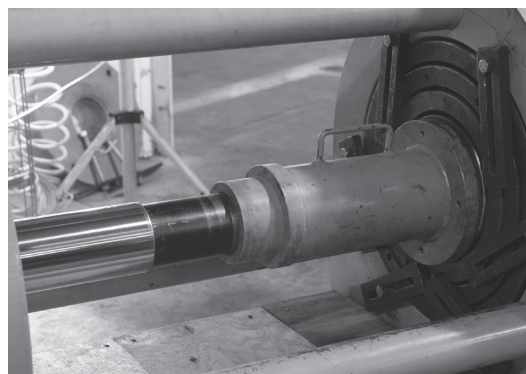

## 13



Lubricate the O.D. of the stem and the I.D. of the hose with Dixon lubricant or equivalent. Insert the end of the fitting into the hose. Assemble the ferrule onto stem by sliding turned over portion of ferrule past notched section of stem collar. Rotate ferrule 90° (¼ turn). With ferrule and stem engaged, continue installing stem until ferrule reaches the second mark on the hose.





*The Right Connection®*

*Section 5*

**100 Ton Ram Operating Instructions  
for  
Cam & Groove  
Holedall™ Couplings**

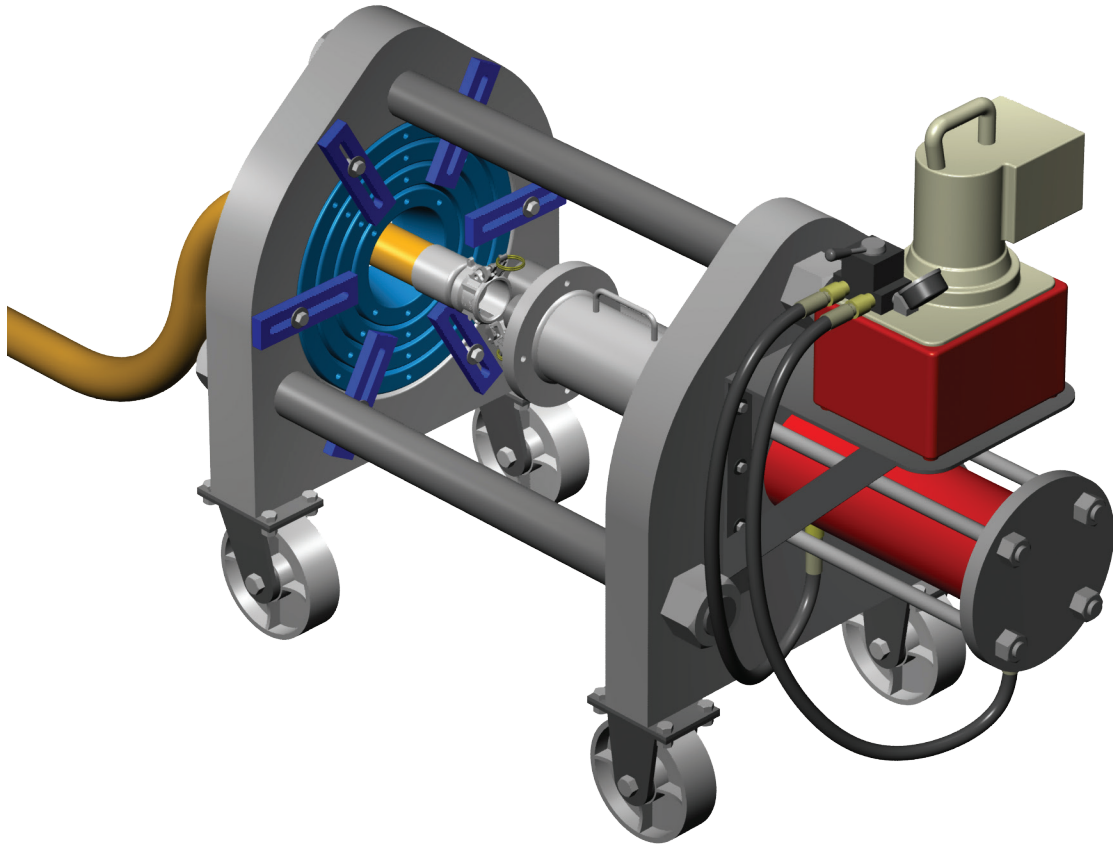

Dixon  
800 High Street • Chestertown, MD 21620  
ph: 877.863.4966 fax: 800.283.4966  
dixonvalve.com

1

Install Main Pusher (**M011-065**) on cylinder rod cap. Make sure that the pusher is fully installed on the rod cap.

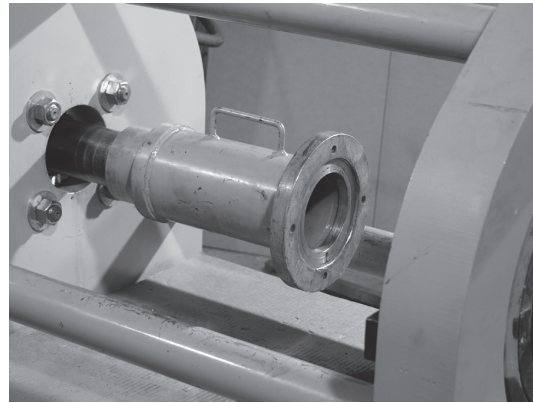

2

Install the Cam & Groove pusher necessary to do the size and style of coupling to be swaged into the Main Pusher (**M011-065**). Additional pushers may be required. Reference the chart at the end of this section for proper pusher selection.

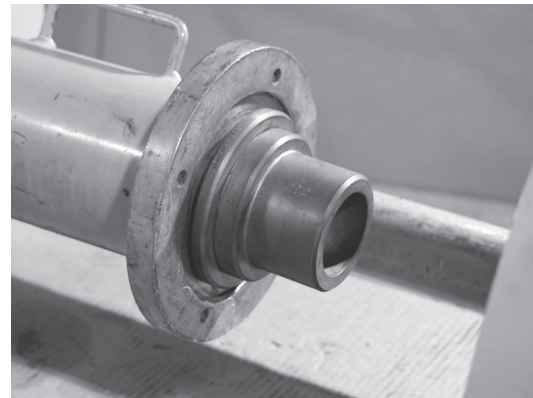

3a

Install the required die holders ensuring that the seams between the die holder halves do not line up. The die holders are designed to fit one inside the other.

A guideline for selecting die holders is:

**DH6-003** ¼" - 1" I.D. hose

**M012-002** 4" - 6" I.D. hose

**M012-003** 6" - 8" I.D. hose

**M012-004** 8" - 10" I.D. hose

**Caution!** Never use a swaging die as a die holder!



3b

Secure the die holders with tie down bars to prevent the die holders from slipping out of the die bed unexpectedly.

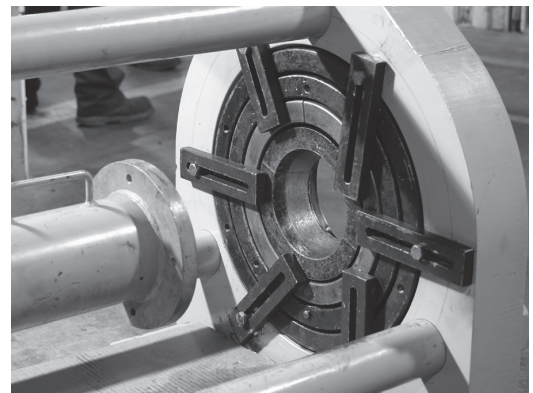



4



Accurately measure the hose O.D. with a diameter tape. Each end of the hose should be measured to guarantee the correct ferrule and die selection. Select the correct ferrule and die based upon the hose free O.D. just measured from the die chart. Make sure that the hose end is cut square. If the hose is to be static grounded, follow hose manufacturers procedure for proper static grounding.

5



Align the end of the hose with the stem shoulder and mark the hose at the end of the stem

6



Place a mark on the outside of the ferrule that corresponds with the center of one of the turned over sections of the ferrule. This mark will act a guide for correct engagement with the stem collar.

7



When using the Notched Stem and Ferrule system these guidelines *must* be followed:

- A. Before stem insertion, assemble the ferrule onto the stem by sliding the turned over portion of the ferrule past the notched sections of the stem collar. Rotate the ferrule 90° (¼ turn).
- B. Before starting the swaging process, make sure that the turned over portion of the ferrule and the collar are fully engaged.
- C. For "C" style couplings (requiring spacer rings), make sure that the two ring halves meet over the turned over portion of the ferrule which should be under the cam arms.

8

Cut the hose end square and if the assembly requires static grounding, follow the hose manufacturer's procedure for proper static grounding. Lubricate the hose I.D. and the O.D. of the stem with Dixon Coupling Lubricant or equivalent. Insert the cam and groove fitting with ferrule onto the hose until the ferrule is even with the mark closest to the hose end. This is the second mark made on the hose.



9

Bring the hose with the stem and ferrule through the die bed. Insert the coupling into or onto the pusher (depending upon coupling style). Make sure that there is sufficient room between the die holders and the end of the ferrule to comfortably insert the die halves into the die holders.

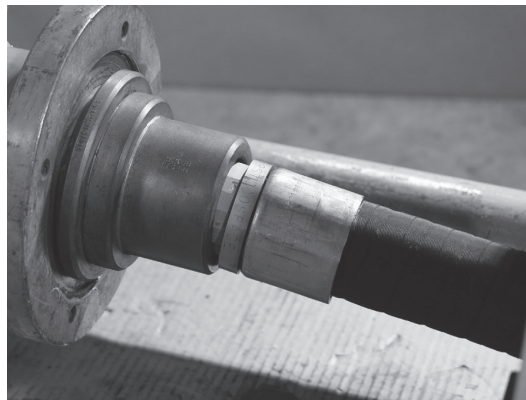

10a

Lubricate the outside of the ferrule with Crisco® (recommended) or high viscosity oil or heavy duty grease.

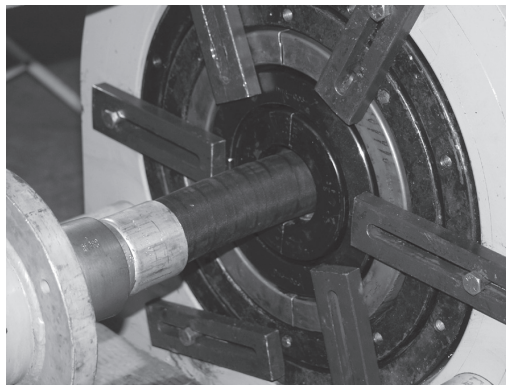

10b

Lubricate the I.D. of both die halves with Crisco® (recommended) or high viscosity oil or heavy duty grease.

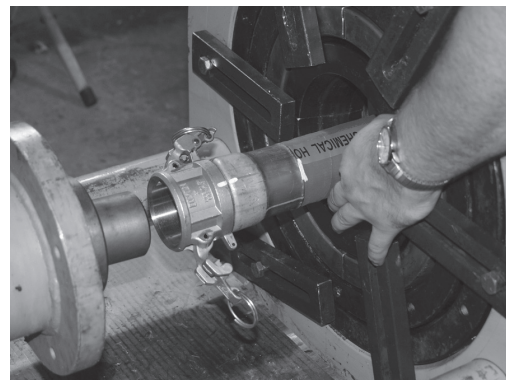

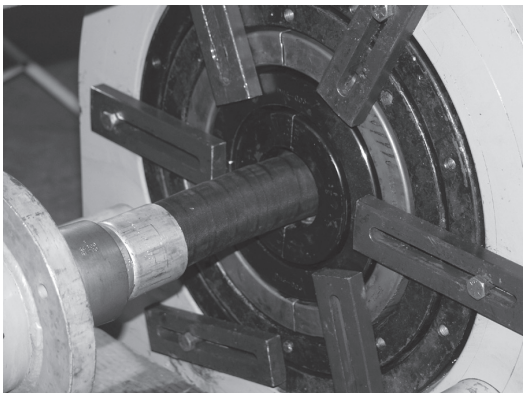
**11a**

Lifting up the hose, insert one die half under the hose. Lower the hose so that it rests on the die. Insert the other die half. Make sure that the seams of the die do not line up with the seams on the die holders.

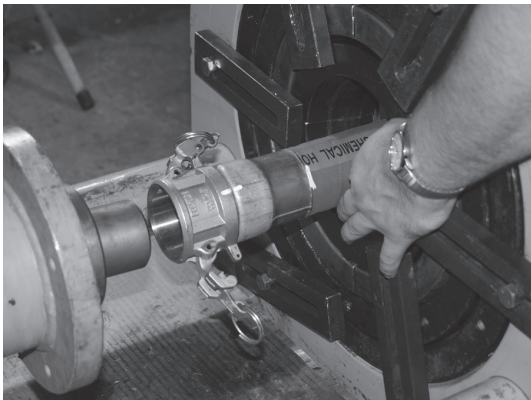
**11b**

While holding the die in place with one hand, place one of the tie down bars over the die so that it does not come out of the die holder unexpectedly. Secure the tie down bar by tightening the bolt.

For style "C" couplings go to step 12.  
For style "E" couplings go to step 13.

For "C" style couplings requiring spacer rings:

12a

Release both cam arms.



12b

Remove the gasket from the coupler.



12c

Put the spacer rings between the ferrule and coupler head, making sure that the two ring halves meet over the turned over portion of the ferrule.



12d

Insert the proper pusher into the coupler (reference the chart at the end of this section for proper pusher selection).



## 12e

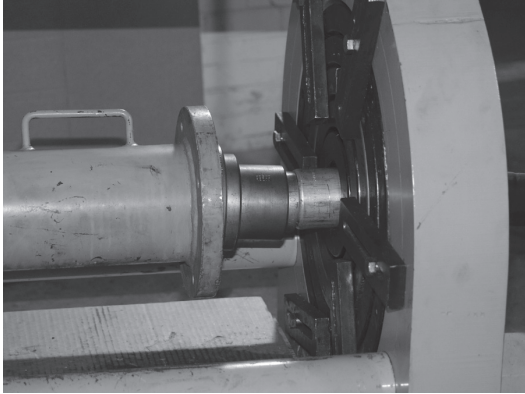

Check the ferrule engagement with the stem collar. The mark on the ferrule (from Step 6a) *must* be positioned under the cam arm.

## 12f

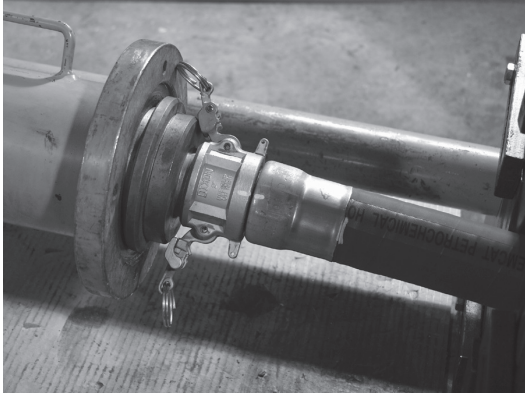

Move the directional control lever to the "FORWARD" position. Depress the button on the remote and advance the cylinder until the end of the ferrule is near the die opening. Using a wooden board or metal pipe, lift the ferrule up. Jog the cylinder by quickly depressing and releasing the button on the remote. This will allow the ferrule to enter the die slowly without contacting the die face. Continue jogging the cylinder until the ferrule has entered the die approximately one half inch.

## 12g

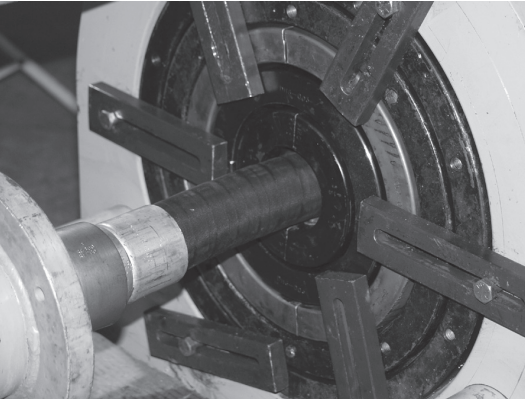

Loosen and move any tie down bars that may come in contact with the coupler head. Depress and hold the button on the remote until the spacer rings are even with or about to contact the die face. Release the button on the remote. Return the directional control lever to the "NEUTRAL" position.

**Note:** If the gauge reads 10,000 PSI before swaging is complete, stop. The ferrule or die used for that hose end may be incorrect. Contact Dixon for further assistance.

## 12h

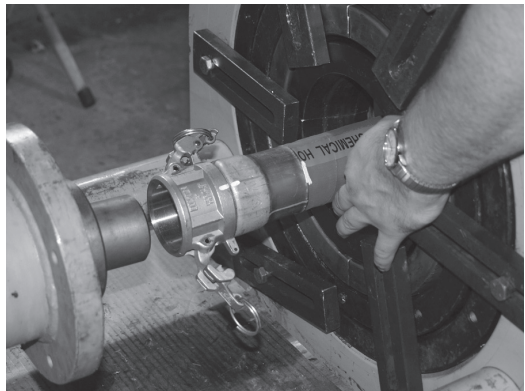

Move the directional control lever to the "REVERSE" position. Depress and hold the button on the remote retracting the cylinder until there is sufficient room for the stem and ferrule to clear the die bed.

## 12i

Position a rubber sheet or pad under the die bed. While holding the die in place with one hand, loosen the bolt on the tie down bar and move the tie down bar so that it clears the die. *Slowly* slide the hose towards the pusher. When the die clears the die holder, one or both halves may fall to the floor. If one half remains on the ferrule, tap it with a mallet until it releases. If both halves remain on the ferrule, it may require the halves be pried apart at the seam.

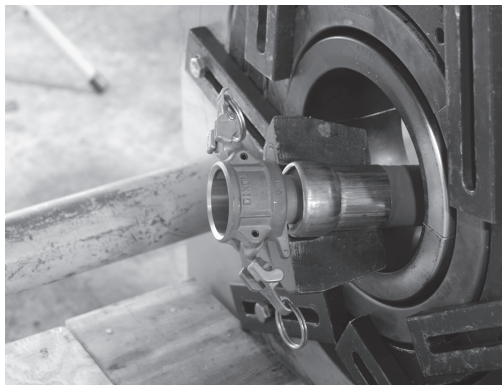

## 12j

Remove the spacer rings from the coupling. Wipe off excess lubricant from hose and ferrule. Bring the hose with stem and ferrule back through the die bed. Reinstall the gasket. Close the cam arms.

**Note:** Remove spacer ring from the 1½" size only.



For "E" style couplings:

13a



Check the ferrule for proper alignment. Ensure that the mark on the ferrule (from Step 6b) is in the center of the stem collar.

13b

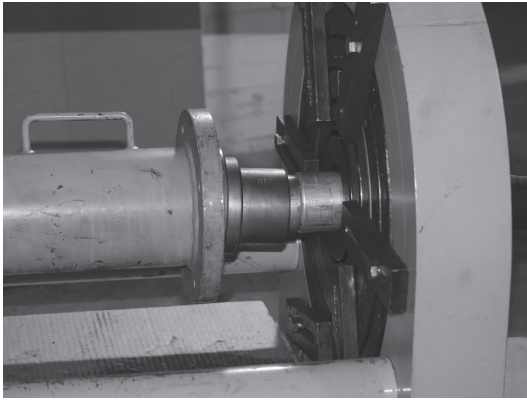

Move the directional control lever to the "FORWARD" position. Depress the button on the remote and advance the cylinder until the end of the ferrule is near the die opening. Using a wooden board or metal pipe, lift the ferrule up. Jog the cylinder by quickly depressing and releasing the button on the remote. This will allow the ferrule to enter the die slowly without contacting the die face. Continue jogging the cylinder until the ferrule has entered the die approximately 1½"

13c

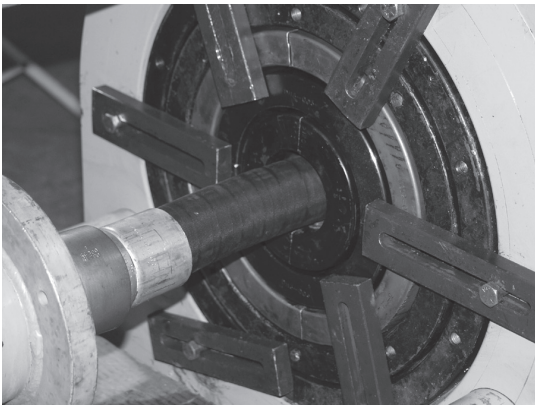

Move any tie down bars from the die that may come in contact with the pusher. While holding the hose and coupling up against the pusher, depress the button on the remote. Once the ferrule has started to be reduced (approximately 1/3 the way) it is no longer necessary for the operator to hold the hose. Continue the swage until the pusher contacts the die face. When this occurs, release the button on the remote and move the directional control lever to the "NEUTRAL" position.

**Note:** If the gauge reads 10,000 PSI before swaging is complete, stop. The ferrule or die used for that hose end may be incorrect. Contact Dixon for further assistance.

13d

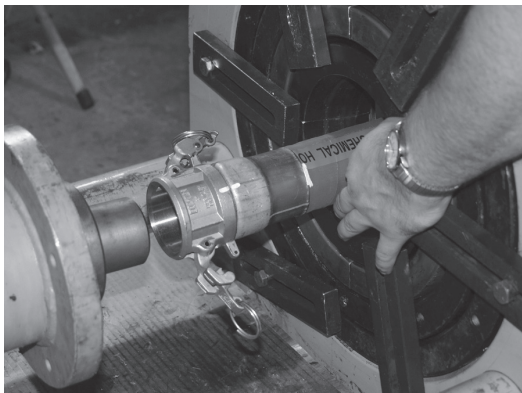

Move the directional control lever to the "REVERSE" position. Depress and hold the button on the remote retracting the cylinder until there is sufficient room for the stem and ferrule to clear the die bed.

**13e**

Position a rubber sheet or pad under the die bed. While holding the die in place with one hand, loosen the bolt on the tie down bar and move the tie down bar so that it clears the die. Slowly slide the hose towards the pusher. When the die clears the die holder, one or both halves may fall to the floor. If one half remains on the ferrule, tap it with a mallet until it releases. If both halves remain on the ferrule, it may require the halves be pried apart at the seam.

**13f**

Wipe excess lubricant from hose and ferrule. Bring hose with stem and ferrule back through die bed.





## Pushers and Spacer Rings for Cam and Groove

Size	Description	Part Number
1"	Type "E" Pusher Type "C" Pusher	<b>100PUSHGCRC</b> <b>100PUSHCGRC</b>
1½"	Type "E" Pusher Type "C" Pusher Spacer Ring	<b>100PUSHCG15E</b> <b>100PUSHCG15 (2 pieces)</b> <b>150CGSPACE</b>
2"	Type "E" Pusher Type "C" Pusher	<b>100PUSHCE2</b> <b>100PUSHCG2</b>
3"	Type "E" Pusher Type "C" Pusher	<b>100PUSHCG3</b> <b>100PUSHCG2</b>
4"	Type "E" Pusher Type "C" Pusher	<b>100PUSHCG4E</b> <b>100PUSHCG4C</b>

**Note:** Spacer Rings are to be used with Type "C" Couplings ONLY. DO NOT use Spacer Rings with Type "E" Couplings, or bodily injury may result.



Dixon recommends that all hose assemblies be tested as recommended by the Association of Rubber Products Manufacturers.





The Right Connection®

*Section 6*

**100 Ton Ram Operating Instructions  
for  
Boss Ground Joint  
Holedall™ Couplings**

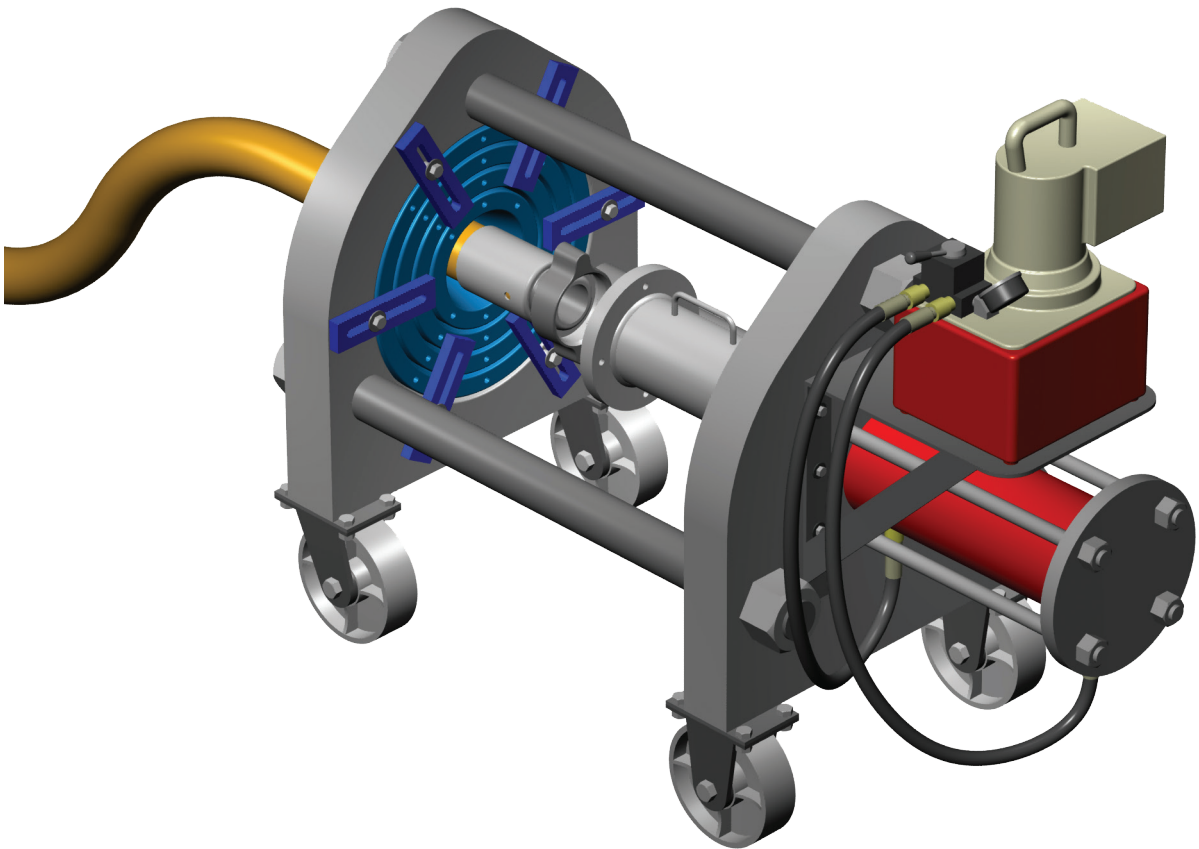

Dixon  
800 High Street • Chestertown, MD 21620  
ph: 877.863.4966 fax: 800.283.4966  
dixonvalve.com

1

Install the 4" Main Pusher (**M011-065**) by sliding it onto the rod cap of the ram cylinder. Make sure that the pusher is all the way on the rod cap. Install the appropriate adapter pusher (by coupling size) into the main pusher.

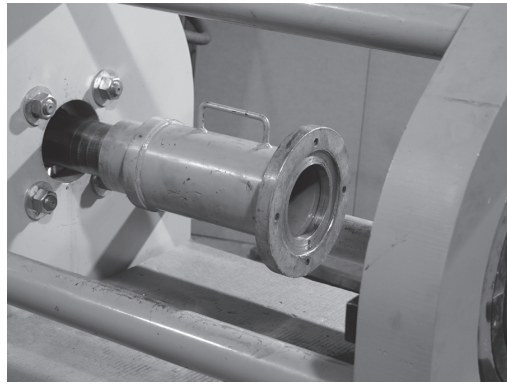

2

Accurately measure the hose O.D. with a diameter tape. Each end of the hose should be measured to guarantee the correct ferrule and die selection. Select the correct ferrule and die based upon the hose free O.D. just measured from the chart.

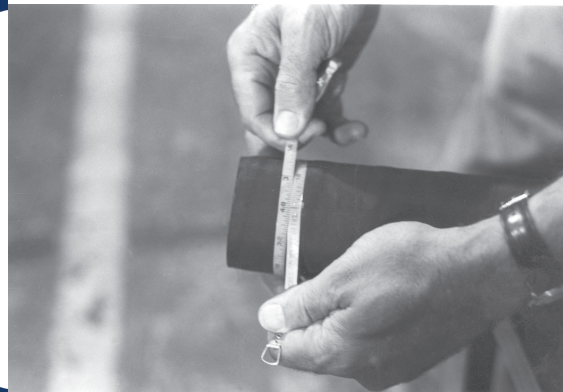

3

Assuring that the hose end is cut square, chamfer the I.D. of the hose  $\frac{1}{8}$ " at a 45° angle. This will aid in stem insertion. If the hose is to be static grounded, follow hose manufacturers procedure for proper static grounding.



4a

Hold the ferrule against the stem collar (sizes 1½" - 3" only). Using a small ruler or other measuring device, insert it between the stem and ferrule until it contacts the stem collar. Measure the depth at the end of the ferrule. Place a mark on the hose (the hose end to be assembled) that corresponds with this measurement.



## 4b



Lubricate the I.D. of the hose and the O.D. of the stem (as well as possible) with Dixon Coupling Lubricant or equivalent. Insert the stem all the way until the mark on the hose (from Step 4a) is at the end of the ferrule.

## 5

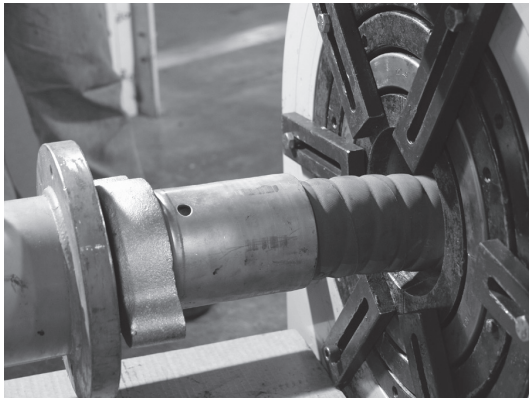

Bring the hose with the stem and ferrule through the die bed. Position the wing nut (or spud) as close to the pusher as possible. Make sure that there is sufficient room between the die holders and the end of the ferrule to comfortably insert the die halves into the die holders.

## 6a



Install the required die holders ensuring that the seams between the die holder halves do not line up. The die holders are designed to fit one inside the other.

A guideline for selecting die holders is:

- DH6-003** ¼" - 1" I.D. hose
- M012-001** 1¼" - 3" I.D. hose
- M012-002** 4" - 6" I.D. hose
- M012-003** 6" - 8" I.D. hose
- M012-004** 8" - 10" I.D. hose

**Caution!** Never use a swaging die as a die holder!



## 6b

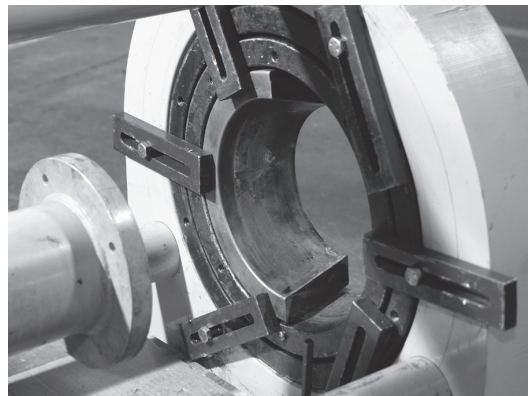

Secure the die holders with tie down bars to prevent the die holders from slipping out of the die bed unexpectedly.

**7a**

Lubricate the outside of the ferrule with Crisco® (recommended) or high viscosity oil or heavy duty grease.

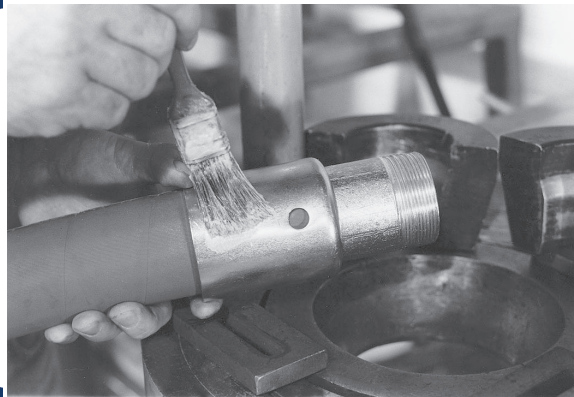
**7b**

Lubricate the I.D. of both die halves with Crisco® (recommended) or high viscosity oil or heavy duty grease.

**8a**

Lifting up the hose, insert one die half under the hose. Lower the hose so that it rests on the die. Insert the other die half. Make sure that the seams of the die do not line up with the seams on the die holders.

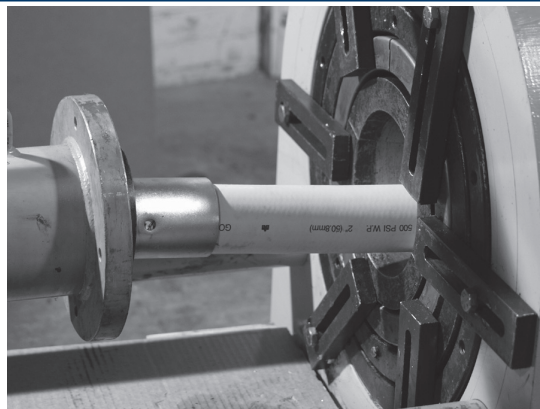
**8b**

While holding the die in place with one hand, place one of the tie down bars over the die so that it does not come out of the die holder unexpectedly. Secure the tie down bar by tightening the bolt.

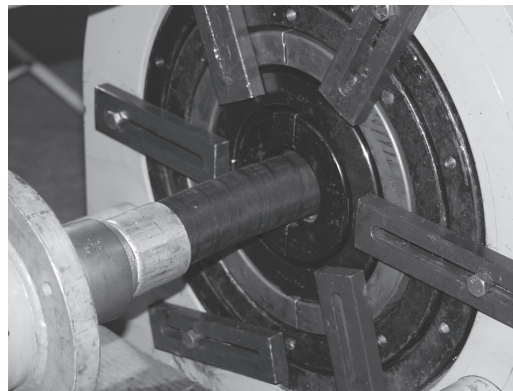

9a

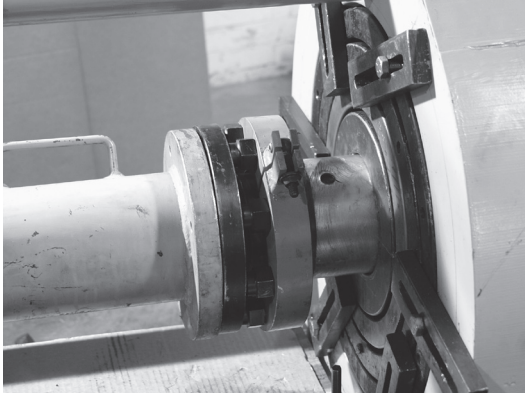

Move the directional control lever to the "FORWARD" position and depress the button on the remote. Advance the cylinder forward until the end of the ferrule is near the die opening. Using a wooden board or metal pipe, lift the ferrule up. Jog the cylinder by depressing and releasing the button on the remote. This will allow the ferrule to enter the die slowly. After the ferrule has entered the die, stop advancing the cylinder.

9

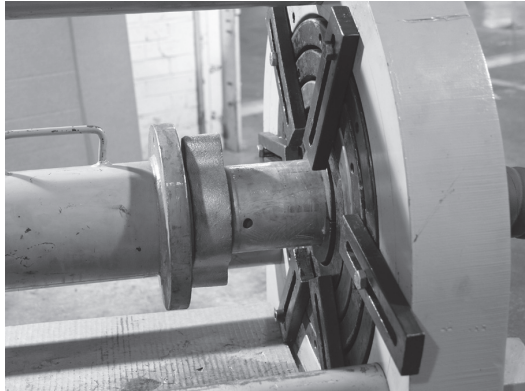

Align the wing nut (or spud) with the pusher ensuring they are flush with each other. Jog the cylinder forward until pressure begins to register on the gauge. Leave the directional control lever in the "FORWARD" position. Check the alignment between pusher and wing nut (or spud). If any adjustment is necessary, do it now.

9c



Reposition the tie down bars on the die face so that the wing nut (or spacer) will clear.

10a



Depress and hold the button on the remote until the wing nut (or spacer) contacts the die face. Release the button. Return the directional control lever to the "NEUTRAL" position.

**Note:** For  $\frac{3}{4}$ " and 1" couplings having the ferrule crimped on, stop the swage when the crimped area of the ferrule begins to enter the die.

**Note:** If the gauge reads 10,000 PSI before swaging is complete, stop. The ferrule or die used for that hose end may be incorrect. Contact Dixon for further assistance.

**10b**

Move the directional control lever to the "REVERSE" position and depress the button on the remote. Retract the cylinder until there is sufficient room for the stem and ferrule to clear the die bed.

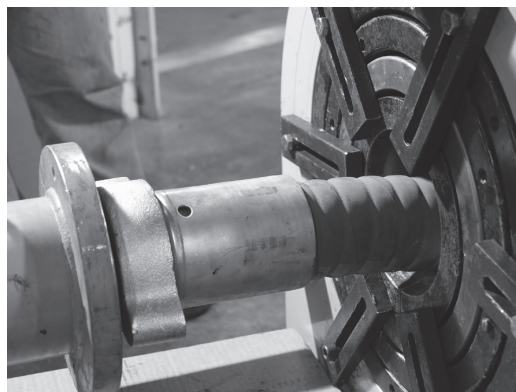
**11a**

Position a rubber sheet or pad under the die bed. Slowly slide the hose towards the pusher. When the die clears the die holder, one or both halves may fall to the floor. If one half remains on the ferrule, tap it with a mallet until it releases. If both halves remain on the ferrule, it may require the halves be pried apart at the seam.

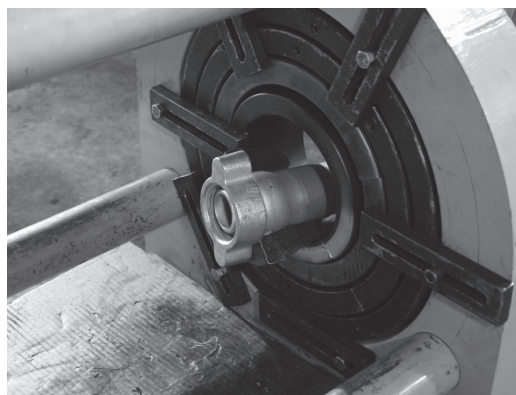
**11b**

Wipe excess lubricant from hose and ferrule. Bring hose with stem and ferrule back through die bed.







*The Right Connection®*

*Section 7*

**100 Ton Ram Operating Instructions  
for  
Converting from  
Swaging to Internal Expansion**

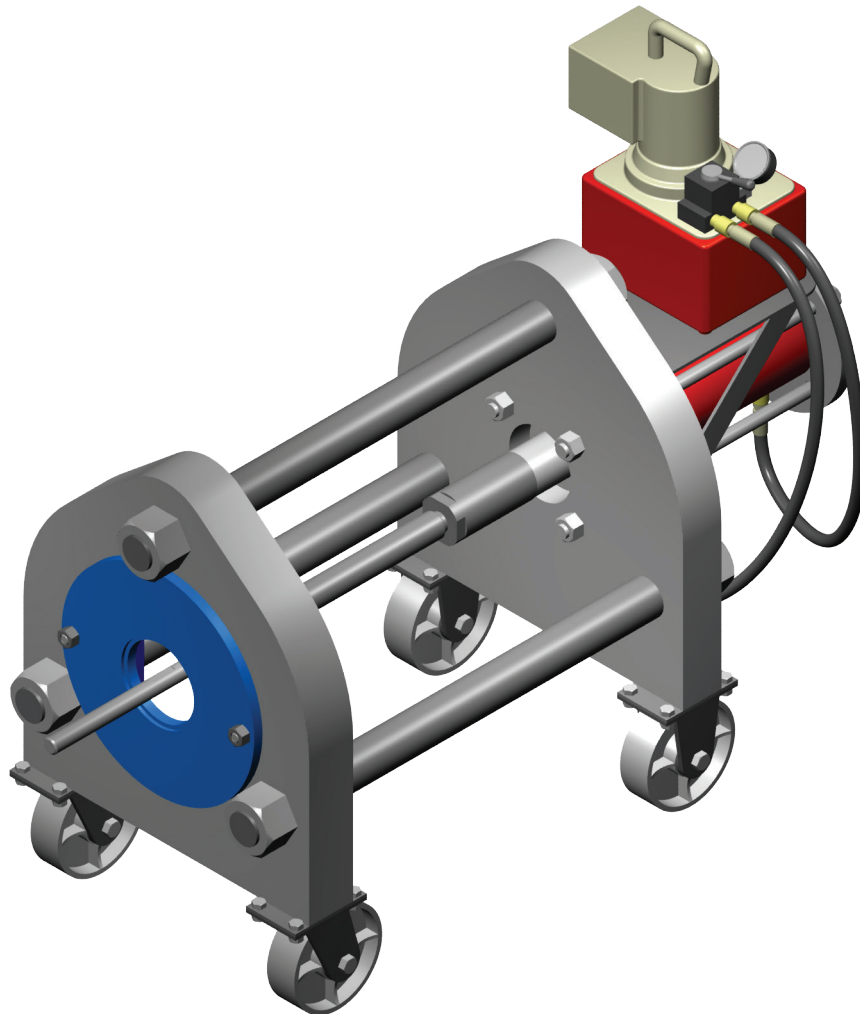

Dixon

800 High Street • Chestertown, MD 21620

ph: 877.863.4966 fax: 800.283.4966

[dixonvalve.com](http://dixonvalve.com)

1

Remove any swaging pusher from the ram cylinder rod cap.

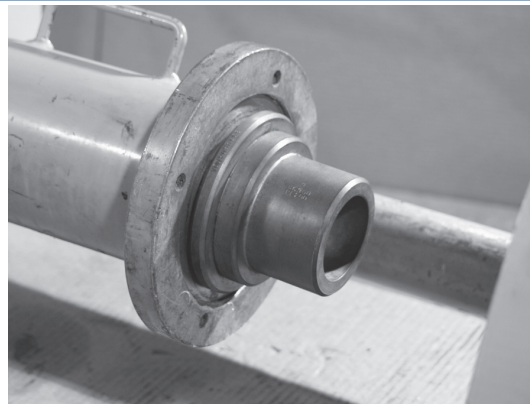

2

Position a rubber mat under the die bed. Position the tie down bars so that only one die bed spacer is clear. Remove the die bed spacer from die bed. Repeat this process until all die bed spacers have been removed from the die bed.

**Caution!** Die bed spacers are heavy. Remove the die bed spacers one half at a time.

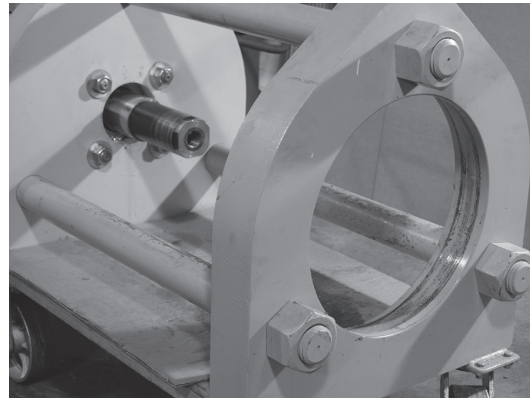

3

Install IX Master Plate onto outside of ram die bed. Position the bolt holes at the 3 o'clock and 9 o'clock positions. Secure with straps and bolts by positioning the straps on the inside of the die bed. Tighten the nuts on the bolts.

**Note:** It may be required to turn one or more of the large nuts on the outside of the die bed. If the IX Master Plate will not fit into the die bed opening, check the nuts to see if the flat on the nut is facing the die bed opening. If not, turn the nut until the flat is facing the opening.

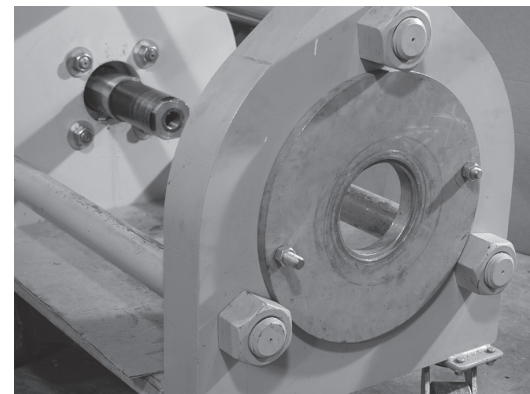

4

Move the directional control lever to the "FORWARD" position. Depress the button on the remote and extend the ram cylinder fully. Release the button on the remote and move the directional control lever to the "NEUTRAL" position. Bring the IX Master Bar through the opening in the IX Master Plate, male thread end first. Thread the male thread on the IX Master Bar into the female thread of the rod cap. Continue to thread the bar in until the shoulder behind the thread on the bar contacts the face of the rod cap.

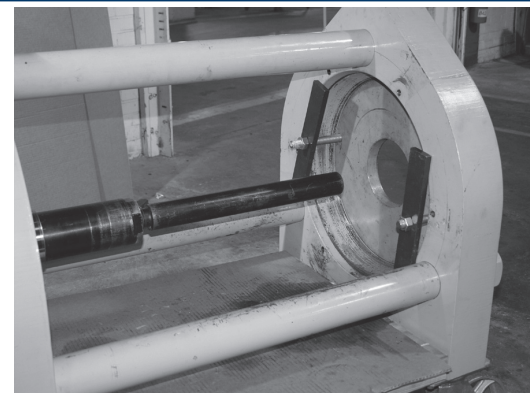



*The Right Connection®*

*Section 8*

**100 Ton Ram Operating Instructions  
for  
Internal Expansion of  
Carbon Steel & Stainless Steel Couplings**

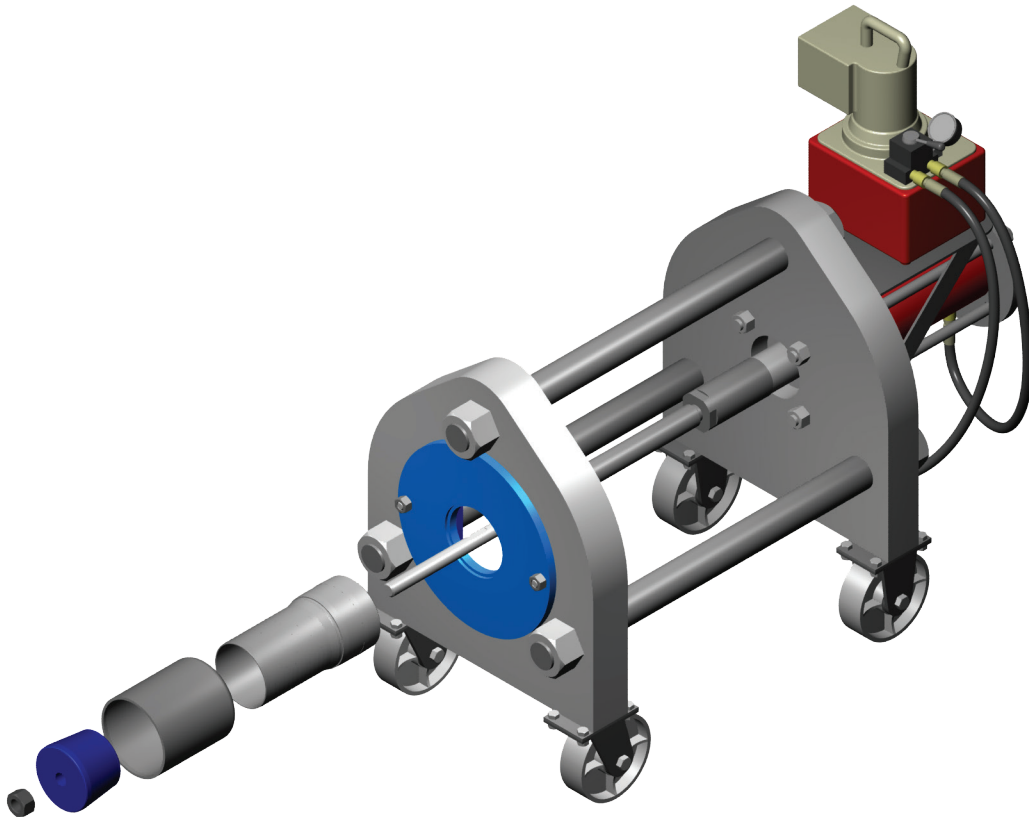

Dixon  
800 High Street • Chestertown, MD 21620  
ph: 877.863.4966 fax: 800.283.4966  
dixonvalve.com

(refer to the Converting the 100 Ton Ram from Swaging to Internal Expansion section of the instruction manual)

1

Before you begin, move the directional control lever to the "FORWARD" position, depress the button on the remote and fully extend the ram cylinder. Return the directional control lever to the "NEUTRAL" position. Select the proper Pull Rod.

For 1" through 1½" use **25RODSMALL**

For 2" through 4" use **25RODLARGE**

For 5" and 6" use **001-0083**

Screw the short threaded end of the rod or the rod adapter into the IX Master Bar.

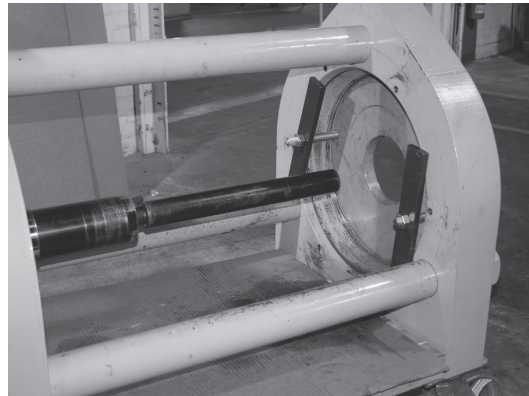

2

Select the corresponding Adapter Plate(s) for the size and type of fitting you are installing. For certain sizes and styles of couplings, multiple adapter plates may be required.

The 2" through 4" adapters have two recesses. The small diameter recess is to be used with stems having NPT, Victaulic or Plain end. The larger diameter recess is used for stems with the "Heavy Duty / California Style" end. The 6" adapter is built into the IX Master plate (**001-0072**).

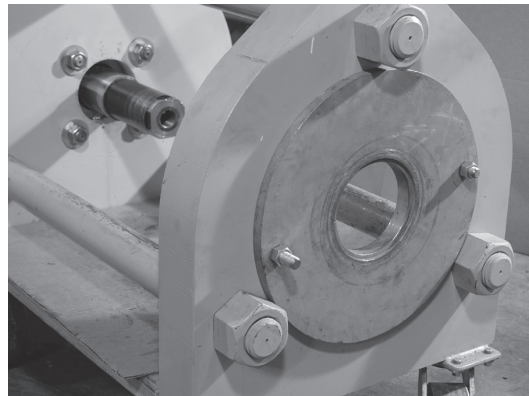

3a

Lubricate the inside of the stem with Crisco® (recommended) or high viscosity oil or heavy duty grease.



3b

Lubricate the O.D. of the plug with Crisco® (recommended) or high viscosity oil or heavy duty grease.



4

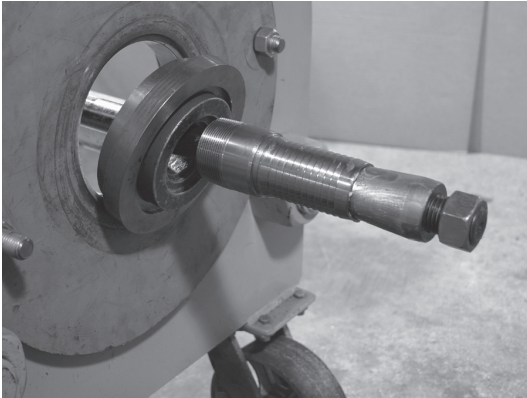

Slide the adapter(s) over the pull rod and into the recess of the IX Master Plate. While holding the adapter(s) in place with one hand, slide the stem over the pull rod and into the recess of the adapter plate with the connection side of the stem facing the ram. While holding the adapter(s) and stem in place with one hand, screw on (or slide) the IX plug, small end first, onto the pull rod and into the shank of the stem. For 2" and above screw the retaining nut on until it contacts the plug. Move the stem slightly to allow for slack and hand tighten the plug or nut until it is snug. Lubricate the rest of the O.D. of the plug.

5



Accurately measure the hose O.D. with a diameter tape. Select the correct IX ferrule from the current Dixon Price List based upon the hose O.D. just measured.

**Note:** Always measure both hose ends for accurate ferrule selection.

6



Make sure the hose end is cut square. Slide the ferrule over the hose until the turned over end of the ferrule contacts the end of the hose. Place a mark on the hose at the junction of the ferrule and hose. Move the ferrule away from the hose end  $\frac{1}{4}$ " and place another mark at the junction of the hose and ferrule. This will ensure that the proper rubber displacement or pocked is maintained during the expansion process.

7



Slide the hose with the ferrule on over the IX plug and shank until the ferrule contacts the shoulder of the stem. Make sure you align the ferrule with the second mark from Step 8. Make sure the pocket has been maintained.

**Important!** If there is insufficient pocket for the rubber to displace into, damage may occur to the stem, ferrule and / or hose. 

1

Place a rubber sheet or pad under the IX Master plate. Move the directional control lever to the "REVERSE" position. While holding the hose and ferrule firmly against the stem shoulder, engage the ram by depressing the button on the remote. The internal expansion operation is complete when the expansion plug is pulled completely through the stem (see Important! below). Release the button on the remote. Visually inspect the coupling and clean excess lubricant from the stem I.D.

**Note:** If the gauge reads 10,000 PSI before swaging is complete, stop. The ferrule or die used for that hose end may be incorrect. Contact Dixon for further assistance.

**Important!** When the pressure gauge drops to zero, release the button on the remote. Pull the assembly off of the plug and, at the same time, remove the adapter(s) from the IX Master Plate.

### Assembly Procedure for 2½" & 4" Threaded Male Stems

In order to prevent possible thread collapse on the 2½" & 4" male NPT stems (carbon steel) during installation, it is recommended that a female threaded adapter be installed prior to installation. The adapter part number for 2½" is **M011-384** and 4" is **M011-385**. Following is the procedure for installation:

1. Lubricate stem I.D. and small end of expansion plug.
2. Thread **M011-384** or **M011-385** onto threads of the male stem *hand tight only!*
3. Slide stem over pull rod thread adapter first.
4. Seat **M011-384** or **M011-385** into outer recess of the adapter.
5. Follow normal IX procedure.
6. When assembly is removed from the adapter, remove **M011-384** or **M011-385** and clean the stem I.D. of excess lubricant.

### Procedure Changes for Stainless Steel Food Grade Couplings

1. Step 3a. - **Must** use Crisco® for lubricant.
2. Step 3b. - **Must** use Crisco® for lubricant.
3. When IX plug is removed and cleaned of lubricant, the visible lines on the plug are deposits of stainless steel. Remove the deposits with 200 - 400 grit wet / dry sandpaper. This is to be done after **every** pull.
4. Make sure the expansion plug to be used has "FD" in the part number (stamped on the large end of the plug). If "FD" is not in the part number **DO NOT USE IT!**



*The Right Connection®*

*Section 9*

**100 Ton Ram Operating Instructions  
for  
Internal Expansion of  
H520 Couplings**

Dixon

800 High Street • Chestertown, MD 21620

ph: 877.863.4966 fax: 800.283.4966

[dixonvalve.com](http://dixonvalve.com)

(refer to the Converting the 100 Ton Ram from Swaging to Internal Expansion section of the instruction manual)

1

Before you begin, move the directional control lever to the "FORWARD" position, depress the button on the remote and fully extend the ram cylinder. Return the directional control lever to the "NEUTRAL" position. Select the proper Pull Rod.

For 1" through 1½" use **25RODSMALL**

For 2" through 4" use **25RODLARGE**

Screw the short threaded end of the rod or the rod adapter into the IX Master Bar.

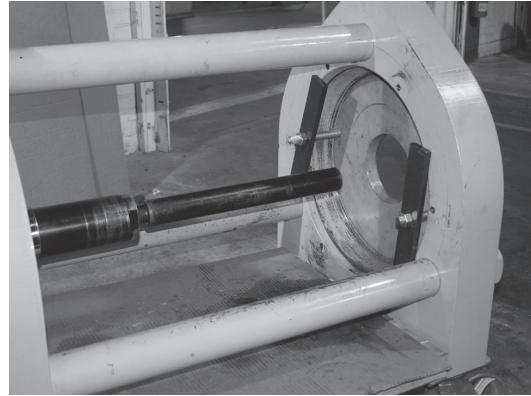

2

Install the Master IX Adapter (**001-0072**) into the Die Bed Plate (**0010-001**). Secure in place using two Adapter Straps (**001-0072A**) and ¾" - 10 UNC x 8" rods.

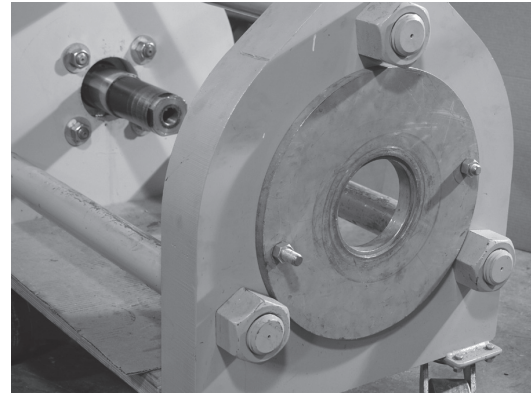

3

Install the **001-067** into the Master IX Adapter opening and secure with Adapter Straps (**25ROSTPA**) and two ½" - 13 UNC Hex Bolts 1⅝" long.

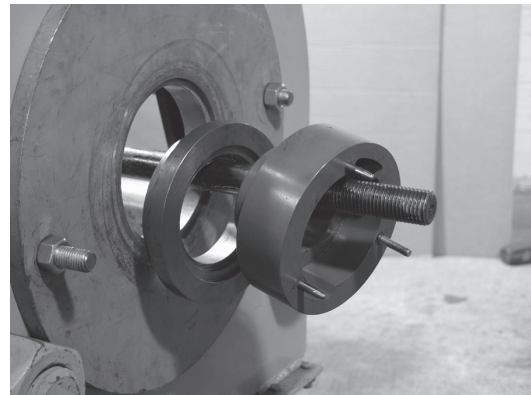

4

Select the corresponding Thrust Plate for the size fitting you are installing. Assuring that the recess is facing outward toward the operator, slide the Thrust Plate over the Pull Rod until it reaches the **25ROSTPA**. Align the holes in the Thrust Plate with the dowel pins on the **25ROSTPA** and slide the Thrust Plate over the pins. Tighten the wing nut to lock in place.

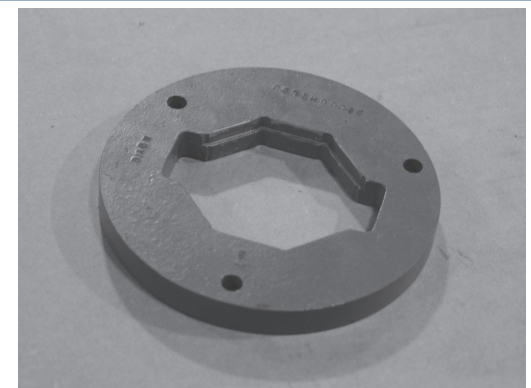



5

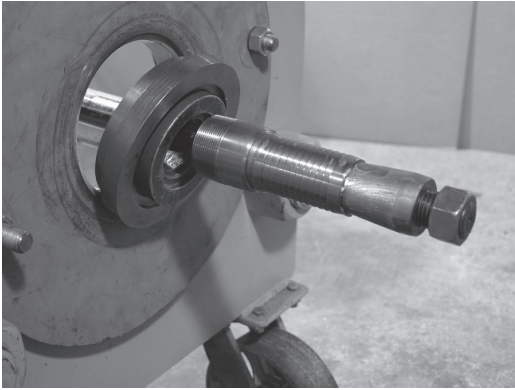

Slide the stem over the Pull Rod and into the recess of the Thrust Plate with the connection side of the stem facing the ram. For male stems, insert the hex into the recess of the Thrust Plate. For female stems, insert the first hex into the Thrust Plate so that the second hex will fit into the recess of the Thrust Plate.

**Note:** There is no need to lubricate the plug or stem. The stems are pre-lubricated at the factory.

6

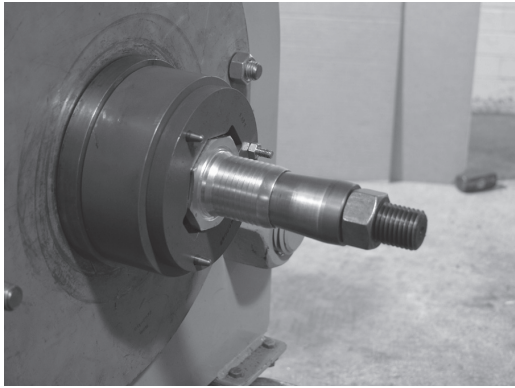

Screw or slide the IX plug, small end first, onto the Pull Rod and into the shank of the stem. For 2" and above screw the retaining nut on until it contacts the plug. Move the stem slightly to allow for slack and hand tighten the plug or nut until it is snug.

7

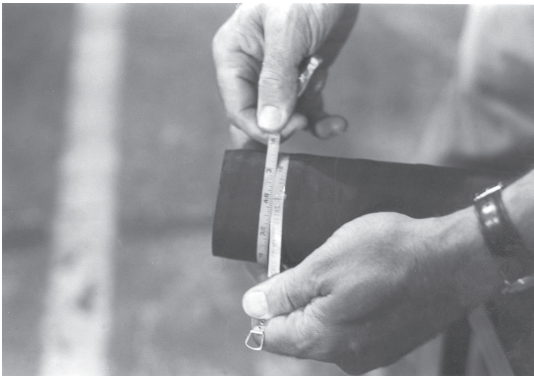

Accurately measure the hose O.D. with a diameter tape. Select the correct Holedall™ Petroleum Ferrule from the DPL based upon the Hose O.D. just measured.

**Note:** Always measure both hose ends for accurate ferrule selection.

8



Make sure the hose end is cut square. Slide the ferrule over the hose until the turned over end of the ferrule contacts the end of the hose. Place a mark on the hose at the junction of the ferrule and hose. Move the ferrule away from the hose end  $\frac{1}{8}$ " and place another mark at the junction of the hose and ferrule. This will insure that the proper rubber displacement or pocket is maintained during the expansion process.

9

Slide the hose with the ferrule on over the shank until the ferrule contacts the shoulder of the stem. Make sure you align the ferrule with the second mark from step 6. Make sure the pocket has been maintained.

**Important!** If there is an insufficient pocket for the rubber to displace into, damage may occur to the stem, ferrule, and /or hose.

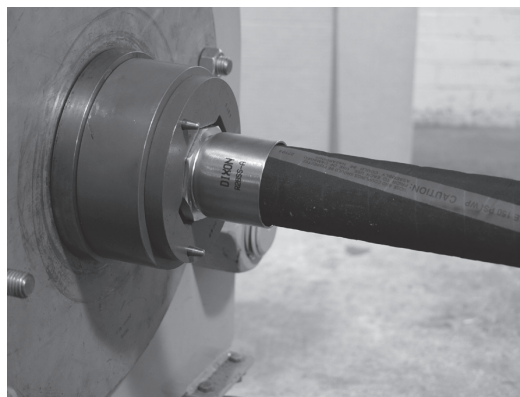

10

While holding the hose and ferrule firmly against the stem shoulder, engage the ram cylinder by stepping on the foot pedal (or depressing the "ON" button on the remote control.) The internal expansion operation is complete when the hose and stem assembly is pushed completely over the internal expansion plug. Release the foot pedal or "ON" switch.

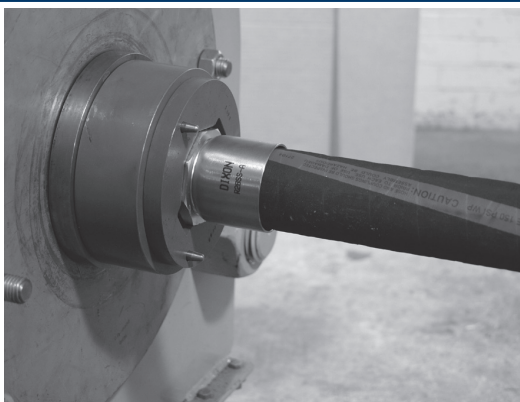

**Note:** If the gauge reads 10,000 PSI before internal expansion is complete, stop. Contact Dixon for further assistance. During internal expansion never stand directly in front of the ram. Visually inspect the coupling.



*The Right Connection®*

*Section 10*

**100 Ton Ram Operating Instructions  
for  
List of Parts and Attachments**

Dixon  
800 High Street • Chestertown, MD 21620  
ph: 877.863.4966 fax: 800.283.4966  
[dixonvalve.com](http://dixonvalve.com)

## Equipment to Swage 1¼" to 10" I.D. Hose Sizes

Part Number	Description
<b>100 TONRAM</b>	"Mulcoram" including motor (115 volt) pump and bed plates 1¼" - 10"

### External Swage Attachments

Please note that on some sizes, more than two attachments may be necessary. Read carefully through all descriptions to determine which attachments are needed for your applications. Please consult Dixon if you need more information.

Part Number	Description
<b>M011-242</b>	10" pusher for all standard length stems with and without flange
<b>M011-249</b>	10" pusher extension for all plain, threaded and grooved end stems (for both standard and long length)
<b>M011-256</b>	10" spacer for all flanged assemblies(for both standard and long length)
<b>M011-254</b>	10" pusher for all long length stems with and without flange
<b>M011-253</b>	10" pusher extension for all plain, threaded, grooved and flanged end long length stems
<b>M011-101</b>	8" pusher for all plain, threaded, grooved and flanged end standard and long length stems.
<b>M011-117</b>	8" pusher extension for all plain, threaded, grooved and flanged end long length stems.
<b>M011-118</b>	8" spacer for all flanged assemblies (for both standard and long length)
<b>M011-070</b>	6" pusher for all plain, threaded, grooved and flanged end standard and long length stems.
<b>M011-073</b>	6" pusher extension for all plain, threaded, grooved and flanged end long length stems.
<b>M011-132</b>	6" spacer for all flanged assemblies(for both standard and long length)
<b>M011-079</b>	5" adapter pusher (fits into 6" pusher). For all plain, threaded, grooved and flanged end standard and long length stems.
<b>M011-076</b>	5" adapter pusher extension for all plain, threaded, grooved and flanged end long length stems
<b>M011-135</b>	5" spacer for all flanged assemblies (for both standard and long length)
<b>M011-065</b>	4" pusher for all stems
<b>M011-131</b>	4" spacer for all flanged assemblies
<b>DH6-003</b>	Die holder needed for 1¼" to 3"
<b>M011-115</b>	3" adapter pusher (fits into 4" pusher). For all stems.
<b>M011-158</b>	3" spacer for all flanged assemblies
<b>M011-114</b>	2½" adapter pusher (fits into 4" pusher). For all stems
<b>M011-274</b>	2½" spacer for all flanged assemblies
<b>M011-113</b>	2" adapter pusher (fits into 4" pusher)
<b>M011-275</b>	2" spacer for all flanged assemblies.
<b>M011-112</b>	1½" adapter pusher (fits into 4" pusher)
<b>M011-111</b>	1¼" adapter pusher (fits into 4" pusher)

## Equipment to Swage 1" through 4" Cam & Groove

Part Number	Description
<b>M011-065</b>	4" pusher (needed for all sizes)
<b>100PUSHCG4E</b>	Pusher for 4" E
<b>100PUSHCG4C</b>	Pusher for 4" C
<b>100PUSHCG3</b>	Pusher for 3" E (fits on 100PUSHCG2)
<b>100PUSHCG2</b>	Pusher for 2" C and E and 3" C (Also use with 100PUSHCGRC and RE100PUSH)
<b>100PUSHCG15</b>	Pusher for 1½" C - consists of the following: <b>100PUSHCG15A</b> - 1½" pusher adapter <b>RC150PUSHB</b> - 1½" pusher
<b>100PUSHCGRC</b>	Pusher for 1" cam and groove couplers (fits inside the 100PUSHCG2)
<b>RE100PUSH</b>	Pusher for 1" E (use with 100PUSHCG2)
<b>RST300SPACE</b>	3" spacer ring for NOS ferrules (use with 100PUSHCG3)
<b>RST200SPACE</b>	2" spacer rings for NOS ferrules (use with 100PUSHCG2)
<b>RST150SPACE</b>	1½" spacer rings for NOS ferrules (use with 100PUSHCG15E)
<b>150CGSPACE *</b>	Spacer rings for 1½" C
<b>100CGSPACE *</b>	Spacer rings for 1" C

Swage dies not included

\* Future designs may not require Spacer Rings. Contact Dixon for more information.

## Holedall™ Dies

Minimum	Maximum
¾" x 9/16"	2" x 1⅞"
2⅛" x 1-11/16"	4½" x 4¼"
4-9/16" x 4-5/16"	6-15/16" x 6-7/16"
7" x 6½"	10" x 9½"
10" x 9½"	12-15/16" x 12⅜"
13" x 12⅜"	16" x 15½"

\* Dies will be invoiced for full selling price when shipped, credit will be issued when returned for full selling price less rental charge. All freight charges are to be paid by Customer. All dies are to be returned within 30 days.

## Equipment to Internally Expand 1¼" - 6" I.D. Hose

### For Use with Steel IX Fittings

Part Number	Description
<b>001-0086</b>	Master IX bar adapter (needed for all sizes)
<b>001-0083</b>	IX bar for 5" - 6"
<b>001-0072</b>	IX master plate (needed for all sizes)(this part is also 6" IX adapter)
<b>25RADLARGE</b>	IX Bar for 2" - 4" - Consists of the following: <b>25RDLG-A</b> - Large Rod for only 25 ton ram <b>25RDLG-B</b> - nut only for 15 & 25 ton rams
<b>25RADSMALL</b>	IX bar for 1¼" and 1½" - consists of the following: <b>25RDSML-A</b> - small pull rod <b>25RDSML-B</b> - small pull rod adapter <b>25RDSML-C</b> - nut for small rod
<b>001-0065</b>	5" IX adapter
<b>001-0067</b>	4" IX adapter (needed for all sizes from 1¼" to 4")
<b>M011-385</b>	4" IX adapter (fits into 001-0067)
<b>25ADAPT300</b>	3" IX adapter
<b>25ADAPT250</b>	2½" IX adapter
<b>M011-384</b>	2½" IX adapter (IXM40 Only). Must be used with 25ADAPT250
<b>25ADAPT200</b>	2" IX adapter
<b>25ADAPT150</b>	1½" IX adapter
<b>25ADAPT125</b>	1¼" IX adapter
<b>25ADAPT100</b>	1" IX adapter

---

## Equipment to Internally Expand 1" - 6" I.D. Hose

### For Use with Steel IX and Holedall™ Petroleum Fittings

Part Number	Description
<b>IXPLUG600</b>	6" IX plug
<b>IXPLUG500</b>	5" IX plug
<b>IXPLUG400</b>	4" IX plug
<b>IXPLUG300</b>	3" IX plug
<b>IXPLUG250</b>	2½" IX plug
<b>IXPLUG200</b>	2" IX plug
<b>IXPLUG150</b>	1½" IX plug
<b>IXPLUG125</b>	1¼" IX plug
<b>IXPLUG100</b>	1" IX plug

## Equipment to Internally Expand "Flow Chief" Food Grade Fittings

Part Number	Description
<b>001-0086</b>	Master IX bar adapter (needed for all sizes)
<b>001-0072</b>	IX master plate (needed for all sizes) (this part is also 6" IX adapter)
<b>001-0067</b>	4" IX Adapter (for male NPT) Needed For All Sizes from 1¼" to 4"
<b>25RODLARGE</b>	IX bar for 2" - 4" - Consists of the following: <b>25RDLG-A</b> - large rod for only 25 ton ram <b>25RDLG-B</b> - nut only for 15 & 25 ton rams
<b>25RODSMALL</b>	IX Bar for 1¼" and 1½" - Consists of the following: <b>25RDSML-A</b> - small pull rod <b>25RDSML-B</b> - small pull rod adapter <b>25RDSML-C</b> - nut for small rod
<b>25ADAPT300</b>	3" IX adapter (for male NPT)
<b>25ADAPT250</b>	2½" IX adapter (for male NPT)
<b>25ADAPT200</b>	2" IX adapter (for male NPT)
<b>25ADAPT150</b>	1½" IX adapter (for male NPT)
<b>PFADAPT400</b>	4" IX sanitary end adapter (Tri Clover style)
<b>PFADAPT300</b>	3" IX sanitary end adapter (Tri Clover style)
<b>PFADAPT250</b>	2½" IX sanitary end adapter (Tri Clover style)
<b>PFADAPT200</b>	2" IX sanitary end adapter (Tri Clover style)
<b>PFADAPT150</b>	1½" IX sanitary end adapter (Tri Clover style)
<b>PFADAPT150-3A</b>	1½" 3A IX sanitary end adapter (Tri Clover style)
<b>PFACNTA400</b>	4" bevel seat acme nut adapter must buy PFADAPT400 to use this part.
<b>PFACNTA300</b>	3" bevel seat acme nut adapter must buy PFADAPT300 to use this part.
<b>PFACNTA250</b>	2½" bevel seat acme nut adapter must buy PFADAPT250 to use this part.
<b>PFACNTA200</b>	2" bevel seat acme nut adapter must buy PFADAPT200 to use this part.
<b>PFACNTA150</b>	1½" bevel seat acme nut adapter must buy PFADAPT150 to use this part.
<b>IXFDPLG400</b>	4" food plugs (for stainless steel fittings)
<b>IXFDPLG300</b>	3" food plugs (for stainless steel fittings)
<b>IXFDPLG250</b>	2½" food plugs (for stainless steel fittings)
<b>IXFDPLG200</b>	2" food plugs (for stainless steel fittings)
<b>IXFDPLG150</b>	1½" food plugs (for stainless steel fittings)
<b>IXFDPLG287</b>	3" food plug for 3A fittings
<b>IXFDPLG187</b>	2" food plug for 3A fittings
<b>IXFDPLG137</b>	1½" food plug for 3A fittings

Dixon™, founded in 1916, is a premier manufacturer and supplier of hose couplings, valves, dry-disconnects, swivels, and other fluid transfer and control products. The company's global reach includes a wide range of products for numerous industries including petroleum exploration, refining, transportation, chemical processing, food & beverage, steel, fire protection, construction, mining and manufacturing. Dixon™'s strategic objective is to create solutions that make products safer, leak-free, longer lasting, and always available.

**dixonvalve.com • Customer Service: 877.963.4966**



*The Right Connection®*

**Dixon™**

800 High Street, Chestertown, MD 21620

ph 877.963.4966

fx 800-283-4966

dixonvalve.com



[dixonvalve.com](http://dixonvalve.com)



[YouTube™](#)



Dixon™  
Customer Service